



WALL-MOUNTED DOMESTIC HOT WATER HEAT PUMP WITH STORAGE TANK

USER'S-INSTALLER'S MANUAL

Model

CALIDO 110



02	10-2020	A.R.	A.R.	Update of technical data and product fiche
01	01-2020	A.R.	A.R.	Phone number added on the declaration of conformity
00	04-2019	AL.B	A.R.	First release
Rev	Date	Edited by	Approved by	Notes
Catalogo / Catalogue / Katalog / Catalogue			Serie / Series / Serie / Serie / Série	
MUI01110L8420-02			SANITARY WATER HEAT PUMP	
Possible wasted electrical or electronic devices/products should not be located together with normal domestic waste, but disposed according to the current WEEE law in compliance with the European Directive 2012/19/UE. Please inform yourself at your local Administration or at your reseller in case the product will be replaced with a similar one.				





ADVANTIX SPA - Via San Giuseppe Lavoratore, 24 - Loc. La Macia - 37040 - Arcole - Verona - Italy - e-mail: info@advantixspa.it - Tel. +39 0457636585

- CE DICHIARAZIONE DI CONFORMITÀ
- CE DECLARATION OF CONFORMITY
- CE ÜBEREINSTIMMUNGSERKLÄRUNG
- CE DECLARATION DE CONFORMITE
- CE DECLARACIÒN DE HOMOLOGACIÒN

DICHIARIAMO SOTTO LA NOSTRA SOLA RESPONSABILITÀ CHE LA MACCHINA
 WE DECLARE UNDER OUR SOLE RESPONSABILITY THAT THE MACHINE
 WIR ERKLÄREN AUF UNSERE ALLEINIGE VERANTWORTUNG, DAß DIE MASCHINE NOUS DECLARONS
 SOUS NOTRE SEULE RESPONSABILITE QUE LA MACHINE
 EL FABRICANTE DECLARA BAJO SU EXCLUSIVA RESPONSABILIDAD QUE LA MÁQUINA

DESCRIZIONE	Pompa di calore per ACS con serbatoio integrato
DESCRIPTION	Heating pump for hot sanitary water production with integrated tank
BESCHREIBUNG	Bomba de calor para la producciòn de agua caliente con tanque integrada
DESCRIPTION	Pompe à chaleur pour production eau chaude sanitaire avec réservoir de stockage intégré
DESCRIPCION	Wärmepumpe für Warmwasserzeugung mit integrierte Speicher

ANNO DI FABBRICAZIONE / YEAR OF MANUFACTURE BAUJAHR /
 ANNEE DE FABRICATION / AÑO DE FABRICACIÓN

2020

MATRICOLA / SERIAL No. / LAUFENDE NUMMER
 NUMÉRO DE SÉRIE / NÚMERO DE SERIE

MODELLO / MODEL / MODELL / MODÈLE / MODELO

CALIDO 110

CODICE A BARRE
BAR CODE

- RISULTA IN CONFORMITÀ CON QUANTO PREVISTO DALLE SEGUENTI DIRETTIVE COMUNITARIE E CON LA RELATIVA LEGISLAZIONE NAZIONALE DIRECEPIMENTO: 2014/30/UE, 2014/35/UE
 EVENTUALI ALTRE DIRETTIVE EUROPEE E NORME ARMONIZZATE APPLICATE ALL'ATTREZZATURA: EMC 2004/108/EC; IEC 60335-2-21; IEC 60335-2-40; EN 55014-1; EN 61000-3-2; EN 61000-3-11.
- IS IN COMPLIANCE WITH THE FOLLOWING EEC DIRECTIVES AND THE RELEVANT NATIONAL GRANTING REGULATIONS IN FORCE: 2014/30/UE, 2014/35/UE
 OTHERS EUROPEAN DIRECTIVES AND HARMONIZED STANDARDS APPLIED TO THE EQUIPMENT: EMC 2004/108/EC; IEC 60335-2-21; IEC 60335-2-40; EN 55014-1; EN 61000-3-2; EN 61000-3-11.
- EST CONFORME AVEC LES DIRECTIVES CEE SUIVANTES ET LES LOIS NATIONALES D'ACCUEIL 2014/30/UE, 2014/35/UE
 AUTRES ÉVENTUELLES DIRECTIVES EUROPÉENNES ET NORMES HARMONISÉES APPLIQUÉES À L'ÉQUIPEMENT: EMC 2004/108/EC; IEC 60335-2-21; IEC 60335-2-40; EN 55014-1; EN 61000-3-2; EN 61000-3-11.
- ESTÀ HOMOLOGADO EN CUANTO PREVISTO DE LAS SIGUENTES DIRECTRICES COMUNITAREAS Y CON LA RELATIVA LEGISLACION NACIONAL DE RECEPCIÒN: 2014/30/UE, 2014/35/UE
 OTRAS DIRECTIVAS EUROPEAS Y NORMAS ARMONIZADAS APLICADAS AL EQUIPAMIENTO: EMC 2004/108/EC; IEC 60335-2-21; IEC 60335-2-40; EN 55014-1; EN 61000-3-2; EN 61000-3-11.
- NACHDEM CEE-NORMEN, SOWIE DER ENTSPRECHENDEN ANGEWENDET STAATS GESETZGEBUNG, DASS HEISST: 2014/30/UE, 2014/35/UE
 EVENTUELLE WEITERE FÜR DAS GERÄT ANGEWANDTE EUROPÄISCHE RICHTLINIEN UND HARMONISIERTE NORMEN: EMC 2004/108/EC; IEC 60335-2-21; IEC 60335-2-40; EN 55014-1; EN 61000-3-2; EN 61000-3-11.

NOME / NAME / VORNAME / NOM / NOMBRE
 COGNOME / SURNAME / NACHNAME / PRENOM / APELLIDO
 POSIZIONE / COMPANY POSITION / POSITION / FONCTION / POSICION

PAOLO
FERROLI

RESP. TECNICO

ARCOLE, 01.2019

INDEX

1	PURPOSES AND CONTENTS OF THE MANUAL	6
1.1	CONSERVATION OF THE MANUAL	6
1.2	GRAPHIC SYMBOLS USED IN THE MANUAL	6
2	SAFETY LAWS	6
3	PERMITTED USE	6
4	GENERAL SAFETY GUIDELINES	7
4.1	WORKERS' HEALTH AND SAFETY	7
4.2	PERSONAL SAFETY EQUIPMENTS	7
4.3	SAFETY SYMBOLS	7
4.4	REFRIGERANT SAFETY DATA SHEET	8
5	GENERAL CHARACTERISTICS	11
5.1	FLEXIBILITY AND BENEFITS OF CALIDO INSTALLATION	11
5.2	COMPACT DESIGN	11
5.3	AVAILABLE ACCESSORIES	11
6	TECHNICAL FEATURES	11
7	ITEMS INSIDE THE PACKING-BOX	12
8	OVERVIEW OF THE UNIT	13
8.1	HYDRAULIC CONNECTIONS	13
8.2	DIMENSIONS	13
8.3	ACCESS TO THE FRONT PART	14
8.4	ACCESS TO THE BOTTOM PART	14
8.5	HOW TO REPLACE THE MAGNESIUM ANODE	14
8.6	REGULATION THERMOSTAT OF THE ELECTRIC HEATER	15
8.7	SCHEMATIC OVERVIEW OF THE WATER AND GAS CIRCUIT	15
9	INSTALLATION	15
9.1	GENERALITY	15
9.2	SAFETY INSTRUCTIONS	15
9.2.1	<i>Warnings</i>	16
9.2.2	<i>Cautions</i>	16
9.3	HANDLING OF THE UNIT	16
9.3.1	<i>Handling of the unit with forklift</i>	16
9.3.2	<i>Manual handling of the unit</i>	16
9.4	WALL MOUNTING	17
9.5	REQUIRED SERVICE SPACE	18
9.6	INSTALLATION OVERVIEW	19
9.7	HYDRAULIC CONNECTIONS	20
9.7.1	<i>Water connections</i>	20
9.7.2	<i>Water loading</i>	20
9.7.3	<i>Unload of water from the tank</i>	21
9.8	ELECTRICAL CONNECTIONS	21
10	START UP	21
11	APPLIANCE OPERATION	22
11.1	USER INTERFACE	22
11.2	OPERATION	22
11.3	LCD ICONS	24
11.4	MAIN LOGICS OF OPERATION	24
11.4.1	<i>Auto mode</i>	25
11.4.2	<i>Green mode</i>	25
11.4.3	<i>Boost mode</i>	25
11.4.4	<i>E-heater mode</i>	25

11.4.5	<i>Fan Mode</i>	25
11.4.6	<i>Operation icons</i>	25
11.5	AUXILIARY CONTROL LOGICS	25
11.5.1	<i>Thermal protections</i>	25
11.5.2	<i>Disinfection weekly cycle (Anti-legionella)</i>	25
11.5.3	<i>ON/OFF contact</i>	26
11.5.4	<i>Contact for photovoltaic plant integration</i>	27
11.5.5	<i>Defrosting cycle</i>	27
11.5.6	<i>Anti-freeze protection</i>	27
11.6	PARAMETERS' CONTROL AND SETTING	28
11.7	MALFUNCTIONING OF THE UNIT AND ERROR CODES	29
12	MAINTENANCE AND PERIODICAL CONTROLS	30
12.1	ENVIRONMENTAL PROTECTION	30
13	TROUBLESHOOTING	31
14	DISPOSAL REQUIREMENTS	31
15	TECHNICAL CHARACTERISTICS	32
16	WORKING LIMITS OF HEAT PUMP	33
17	WIRING DIAGRAM	34
18	FICHE ACCORDING TO REGULATION (EU) NO 812/2013	35
19	TECHNICAL PARAMETERS ACCORDING TO REGULATION (EU) NO 814/2013	35

This manual collects all relevant information for the use of the apparatus in best way and under operators' safety conditions.

1 PURPOSES AND CONTENTS OF THE MANUAL

This manual provides the required information as for the installation, operation and maintenance of CALIDO units. It is addressed to the machine's operators enabling them to use the equipment efficiently, even if without having any previous specific knowledge of the apparatus.

This manual describes the characteristics of the equipment when it is being put on the market; therefore, it may not capture later technological improvements introduced by the company as part of its constant endeavour to enhance the performance, ergonomics, safety and functionality of its products.

The company, therefore, is not constrained to update the manuals for previous versions of machines.

It's recommended that to the user to follow the instructions contained in this booklet, especially those concerning the safety and routine maintenance.

1.1 CONSERVATION OF THE MANUAL



The manual has to be always kept as reference of the appliance. It has to be stored in a safe place, away from the dust and moisture. It has to be accessible to all users who shall consult it any time they are in doubt on how to operate the equipment.

The company reserves the right to modify its products and related manuals without necessarily updating previous versions of the reference material. It assumes no responsibility for any inaccuracies in the manual, if due to printing or transcription.

The customer shall store any updated copy of the manual or parts of it delivered by the manufacturer as an attachment to this manual.

The company is available to give any detailed information about this manual and to provide information regarding the use and the maintenance of its own appliances.

1.2 GRAPHIC SYMBOLS USED IN THE MANUAL

	<i>Indicates operations that can be dangerous for people and/or disrupt the correct operation of the equipment.</i>
	<i>Indicates prohibited operations.</i>
	<i>Indicates important information that the operator has to follow in order to guarantee the correct operation of the equipment in complete safety. It indicates also general notes.</i>

2 SAFETY LAWS

CALIDO units have been designed in compliance with the following Directives and Harmonised Norms:

- Community Directives: 2014/30/UE, 2014/35/UE;
- Norms: EMC 2004/108/EC; IEC 60335-2-21; IEC 60335-2-40; EN 55014-1; EN 61000-3-2; EN 61000-3-11;

3 PERMITTED USE

- The company excludes any contractual and no-contractual liability for damages caused to persons, animals or things, by incorrect installation, adjustment and maintenance, improper use or a partial or superficial reading of the informations contained in this manual.
- These units have been designed for water heating. A different application, unless expressly authorized by the manufacturer, is to be considered improper and therefore not allowed.
- The location and the hydraulic and electric plant should be determined by the system designer and must take into account both the purely technical needs as any applicable local legislations and specific authorizations.
- The execution of all work must be performed by qualified and experienced personnel, competent in the existing rules in different countries

4 GENERAL SAFETY GUIDELINES

Before beginning to operate on the “CALIDO” units, every user has to be perfectly knowledgeable about the functions of the equipment and its controls and should read and understand the information listed in this manual.

	<i>It's strictly forbidden to remove and/or tamper with any safety device. Do not remove the grills on the fan outlet and top cover.</i>
	<i>It's forbidden the use by children and unassisted disabled persons.</i>
	<i>Do not touch the appliance when barefoot or with wet or damp parts of the body.</i>
	<i>Do not pull, detach or twist the electrical cables coming from the unit, even if it is disconnected from the mains supply.</i>
	<i>Do not stand with your feet on the device, sit down and/or lean on any type of object.</i>
	<i>Do not spray or pour water directly on the device.</i>
	<i>Not dispose of, abandon or leave within reach of children packaging materials (cardboard, staples, plastic bags, etc.) because it can be a potential source of danger.</i>
	<i>Any routine or not-routine maintenance operation shall be carried out when the equipment has been shut down, disconnected from electric power sources.</i>
	<i>The plastic cover can be removed only by qualified operators.</i>
	<i>Do not put neither your hands nor insert screwdrivers, spanners or other tools into moving parts of the equipment.</i>
	<i>The equipment supervisor and the maintenance man has to receive suitable training for the performance of their tasks in safety.</i>
<i>Operators have to know how to use personal protective devices and have to know the accident-prevention guidelines contained in national and international laws and norms.</i>	

4.1 WORKERS' HEALTH AND SAFETY

The European Community has adopted a number of directives on workplace's health and safety, which include 89/391/CEE, 89/686/CEE, 2009/104/CE, 86/188/CEE and 77/576/CEE directives. Every employer shall implement such provisions and ensure that workers respect them:

	<i>Do not tamper with or replace parts of the equipment without the specific consent of the manufacturer. The manufacturer shall have no responsibility whatsoever in case of unauthorised operations.</i>
	<i>Using components, expendable materials or spare parts that do not correspond to those recommended by the manufacturer and/or listed in this manual may be dangerous for the operators and/or damage the equipment</i>
	<i>The operator's workplace has to be kept clean, tidy and free from objects that may prevent free movements. Appropriate lighting of the work place shall be provided so as to allow the operator to carry out the required operations safely. Poor or too strong lighting can cause risks.</i>
	<i>Ensure that work places are always adequately ventilated and that aspirators are working, in good condition and in compliance with the requirements of the laws in force.</i>

4.2 PERSONAL SAFETY EQUIPMENTS

When operating and maintaining the CALIDO units, use the following personal protective equipments.

	<i>Protective clothing: Maintenance men and operators has to wear protective clothing that complies with the basic safety requirements currently in force. In case of slippery floors, users have to wear safety shoes with non-slip soles.</i>	
	<i>Gloves: During maintenance or cleaning operation protection gloves have to be used</i>	
		<i>Mask and goggles: Respiratory protection (mask) and eye protection (goggles) should be used during cleaning and maintenance operations.</i>

4.3 SAFETY SYMBOLS

The unit features the following safety signs, which has to be complied with:

	<i>General hazards</i>
	<i>Electric shock hazard</i>
	<i>Presence of moving organs</i>
	<i>Presence of surfaces that may cause injuries</i>

4.4 REFRIGERANT SAFETY DATA SHEET

Extract from the safety data sheet in accordance with Regulation (EC) No. 1907/2006 (REACH) with the modification of Regulation (EU) 2015/830.

Denomination:	R134a (100% ,1,1,2-Tetrafluoroethane).
Reference of SDS	Not subject to registration obligations as downstream users of substances/preparations already registered

IDENTIFICATION OF THE SUBSTANCE/MIXTURE AND OF THE COMPANY/ENTERPRISE

1.1. Product identifier

Chemical name:	133	
CAS number:	811-97-2	
CE number:	212-377-0	
Index number:	---	
Registration number:	01-2119459374-33	
Chemical formula:	C2H2F4	

1.2. Relevant identified uses of the substance or mixture and uses advised against

Identified uses:	Refrigerant
------------------	-------------

HAZARDS IDENTIFICATION

2.1. Classification of substance or mixture

Regulation (EC) No 1272/2008 classification

Physical hazards	Gases under pressure: Liquefied gas H280	
Indications of danger	May explode if heated	
Health hazards	Asphyxia	
	Rapid evaporation can cause frostbite	
	May cause cardiac arrhythmia.	

FIRST AID MEASURES

4.1. Description of first aid measures

General information:	Do not give anything to an unconscious person. Get medical assistance.
Inhalation:	Move the victim to an uncontaminated area wearing the self-contained breathing apparatus. Keep the patient relaxed and warm. Proceed with artificial respiration if breathing stops. Adrenaline and similar substances should not be administered.
Eye contact:	Rinse carefully with plenty of water for at least 15 minutes and consult a doctor.
Ingestion:	The ingestion is considered an unlikely mode of exposure.
Skin contact:	In case of freezing cold, spray with water for at least 15 minutes. Apply a sterile gauze. Take off contaminated clothing immediately.

4.2. Most important symptoms and effects, both acute and delayed

High concentration can cause asphyxia. Symptoms may include loss of mobility and/or consciousness. Victims may not be aware of asphyxia.
Low concentration can have a narcotic effect. The symptoms may include dizziness, headache, nausea and loss of coordination.

FIRE PREVENTION MEASURES

5.1. Fire extinguishing media

Suitable extinguishing media:	Water spray.
Unsuitable extinguishing media:	Do not use water jets to extinguish the fire.

5.2. Special hazards from the substance or mixture

Specific hazards:	The exposure to flames can cause the unit to break or explode due to increased pressure. In the event of a fire, the following products may originate due to thermal decomposition:
Hazardous combustion products:	Carbon monoxide Hydrofluoric acid Carbonyl fluoride

5.3. Recommendations for firefighters

Specific methods:	Coordinate fire fighting according to the surrounding fire. Exposure to flames and heat can cause the unit to break. Cool down with a shower of water from a protected position. Do not spill contaminated fire water into the sewage system. If possible stop product leakage. If possible, use water spray to remove the fumes.
Special protective equipment for firefighters:	Use self-contained breathing apparatus. Standard protective clothing and protective equipment (breathing apparatus) for firefighters. EN 137 - Respiratory protective devices - Self-contained open-circuit compressed air breathing apparatus with full face mask. EN 469: Protective clothing for firefighters. EN 659: Protective gloves for firefighters.

MEASURES IN CASE OF ACCIDENTAL LEAKAGE

6.1. Personal precautions, protective equipment and emergency procedures

Individual precautions:	Try to stop the leakage. Evacuate the area. Use self-contained breathing apparatus to enter into the affected area if there is no evidence of breathable atmosphere. Ensure adequate ventilation. Prevent entry into sewers, basements, excavations and areas where accumulation can be dangerous. Operate according to the local emergency plan. Stay upwind. Evacuate civilians in security areas. Use personal protective equipment.
-------------------------	---

Environmental precautions:	Volatile
Cleaning methods:	Volatile

HANDLING AND STORAGE

7.1. Safe-handling precautions	
Safe use of the product:	The product must be handled in accordance with good industrial hygiene and safety practices. Only experienced and properly instructed persons can manipulate gases under pressure. Do not smoke while handling the product.
	Use only specific equipment that are suitable for the product and for the operating pressure and temperature. In case of doubt, please contact the supplier. Do not breathe the gas. Don't release the product in the atmosphere. You must ensure sufficient air exchange and/or suction. Do not use direct flame or electric heating to increase internal pressure. Do not remove or render illegible the affixed supplier identification labels. Do not undergo any pressure test with the air /HFC-134a mixtures.
	Gas-air can form a combustible mixture at pressures higher than the atmospheric one when the volume ratio exceeds 60%.
Storage:	Keep the unit away from incompatible products such as: explosive, flammable materials, Organic peroxide

EXPOSURE CONTROL / INDIVIDUAL PROTECTION

8.1. Control parameters	
DNEL: Derived level without effect (workers)	
Effects of long-term - systemic effects, inhalation	14000 mg/m ³
PNEC = Predicted No Effect Concentration	
Water (soft water)	0,1 mg/l
Wate (Sea water)	0,01 mg/l
Aquatic, intermittent releases	1 mg/l
Sediment, soft water	0,75 mg/kg dry weight
PNEC for microorganisms or wastewater treatment plant	
	73 mg/l

8.2. Exposure controls	
Protection of eyes:	Total protective glasses. Protective goggles should be worn during the refilling operations. EN 166 - Personal eye protection
Protection of hands:	Protective gloves should be worn when handling gas containers. EN 388 - Protective gloves against mechanical risks.
Generic protection:	Safety shoes should be worn when handling containers EN ISO 20345 - Personal protective equipment - Safety footwear
Respiratory protection:	Under-oxygenated environments, a breathing apparatus or mask breathing air supply system must be used. EN 137 - Respiratory protective devices - Self-contained open-circuit compressed air breathing apparatus with full face mask.
Hygiene measures:	Don't smoke.

8.2.3. Environmental exposure controls	
	Refer to local legislation for restrictions to emissions in the atmosphere. See the section on specific gas treatment / disposal methods.

PHYSICAL AND CHEMICAL PROPERTIES

9.1. Basic information about the Physical and Chemical properties.	
Aspet:	Physical state at 20°C / 101.3kPa: Colorless liquefied gas.
Odor:	Similar to ether.
Olfactory threshold:	The olfactory threshold is subjective and inadequate to warn of overexposure.
Melting point	-101°C
Boiling point:	-26.5°C
Ignition point:	Not flammable
Critical temperature [°C]	101°C
Relative density, gas (air = 1):	3,6
Water solubility:	1930 mg/l

9.2. Other information	
	Gas/vapor more heavier than air. May accumulate in confined spaces, particularly at or below ground level.

STABILITY AND REACTIVITY

Stability:	No reactivity if used with the appropriate instructions.
Incompatible materials:	Humidity. Refer to ISO 11114 standard for further information on material compatibility.
Hazardous decomposition products:	Halogen acids, carbon dioxide (CO ₂), carbon monoxide, fluorocarbons, carbonyl halides.
Dangerous reactions:	The product is not flammable in contact with air under normal conditions of temperature and pressure. Under pressure with air or oxygen, the mixture can become flammable. Some mixtures of HCFC or HFC and chlorine may become flammable or reactive under certain conditions.

TOXICOLOGICAL INFORMATION

Acute toxicity:	LC50 / inhalation / 4 hours / on rat> 567000 ppm / 4h EC50 48h - Daphnia magna> 930 mg/l LC50 96h - Fish> 450 mg / l No known effect of this product.
Local effects:	Concentrations substantially above the TLV (1000 ppm) value may cause narcotic effects. Inhalation of decomposition products in high concentration may cause shortness of breath (lung oedema)
Long-term toxicity:	Did not show carcinogenic, teratogenic or mutagenic effects on animal experiments. Can cause cardiac arrhythmia. Limit threshold for cardiac sensitivity: 312975 mg/m ³ . Limit threshold for anesthetic effects: 834600 mg/m ³

ECOLOGICAL INFORMATION

Not easily biodegradable.

Not considered susceptible to bioaccumulation due to a low log Kow (log Kow <4).

Because of its high volatility, the product is unlikely to cause soil and groundwater pollution.

Not classified as PBT or vPvB.

12.6. Other adverse effects

Effects on the ozone layer Any

Global Warming Potential 1430

GWP (CO₂=1):Effects on global warming If discharged in large quantities it can contribute to the greenhouse effect
It contains fluorinated greenhouse gases regulated by the Kyoto protocol

DISPOSAL CONSIDERATIONS

13.1. Waste treatment methods

Refer to the supplier gas recovery program.

Avoid direct discharge into the atmosphere.

Do not discharge where the accumulation can be dangerous.

Make sure that the emission limits set by local regulations or indicated in the authorizations are not exceeded.

For further information regarding the suitable disposal methods, consult the EIGA Code of Practice

Doc 30 "Disposal of gases", available at <http://www.eiga.org>List of hazardous waste 14 06 01 *: chlorofluorocarbons, HCFC, HFC

5 GENERAL CHARACTERISTICS

The hot water heat pump is one of the most economical systems to heat the water for family domestic uses or for small business activities. Using free renewable energy from the air, the unit is highly efficient with low running costs. Its efficiency can be up to 3~4 times more than conventional gas boilers or electrical heaters.

5.1 FLEXIBILITY AND BENEFITS OF CALIDO INSTALLATION

Waste heat recovery: the unit can be installed near the kitchen, in the boiler-room or the garage, basically in every room which has a large number of waste-heat so that it has the higher energy efficiency even with very low outside temperatures during the winter.



Hot water and dehumidification: the unit can be placed in the laundry room or clothing room. When it produces hot water it lowers the temperature and dehumidifies the room as well.



Storage room cooling: the unit can be placed in the storage room as the low temperature helps to keep the food fresh.

Hot water and fresh air ventilation: the unit can be placed in the garage, gym, basement etc. When it produces hot water, it makes cold the room and then provides fresh air.

Ecological and economical heating: the unit is one of the most efficient and economical alternatives to both fossil fuel boilers and heating systems. By making use of the renewable source in the air, it consumes much less energy.

Multiple functions: the special design of the air inlet and outlet makes the unit suitable for various ways of connections. With different ways of installation, the unit can work as just a heat pump but also as a fresh air blower, a dehumidifier, or an energy recovery device.



The function for which the unit has been designed is only that of heat pump for DHW production. Any other side effect (ambient cooling, dehumidification, waste heat recovery) should be considered as a perk, on which you can not have however precise control. The performance data will therefore be provided only with respect to the function of water heating.

5.2 COMPACT DESIGN

The unit is designed in particular for supplying hot water for domestic use or for small commercial activities. The highly compact structure and elegant design of the appliance are studied in order to make it easy and simple for internal installation.

5.3 AVAILABLE ACCESSORIES

Available accessories are:

- Vibration damper supports for floor installation.



6 TECHNICAL FEATURES

- ✓ Steel tank with double layer vitrification.
- ✓ Anti-corrosion magnesium stick for assuring the durability of the tank.
- ✓ Condenser wrapped externally to the boiler, free from fouling and refrigerant with oil-water contamination.
- ✓ High thickness polyurethane foam (PU) thermal insulation.
- ✓ External structure made of sheet metal in two colors: the lower part in RAL 9003, the upper part in RAL 7035.
- ✓ Outer shell made of grey colour RAL 9006 plastic material.
- ✓ Highly efficient compressor with the R134a refrigerant.
- ✓ High and low gas pressure protections.
- ✓ Electrical heater available in the unit as a back-up (with integrated thermostat with protection temp. at 85°C+/-5°C), assuring constant hot water even in extreme cold winters.

- ✓ ON-OFF contact for starting the unit from an external switch.
- ✓ Weekly disinfection cycle.
- ✓ Possibility of on/off contact management in order to turn on/off the unit when is required; it could be used for exemple when you have the production of a photovoltaic system maximizing the self-consumption and energy efficiency.

7 ITEMS INSIDE THE PACKING-BOX

Before starting the installation, please make sure that all parts are found inside the box.

PACKING-BOX		
Item	Image	Quantity
Domestic hot water heat pump		1
User's-Installer's manual		1
Dielectric joints	Built-in	2
8 bar pressure relief valve	Included	1
Brackets for wall mount and screws	Included	2

8 OVERVIEW OF THE UNIT

8.1 HYDRAULIC CONNECTIONS

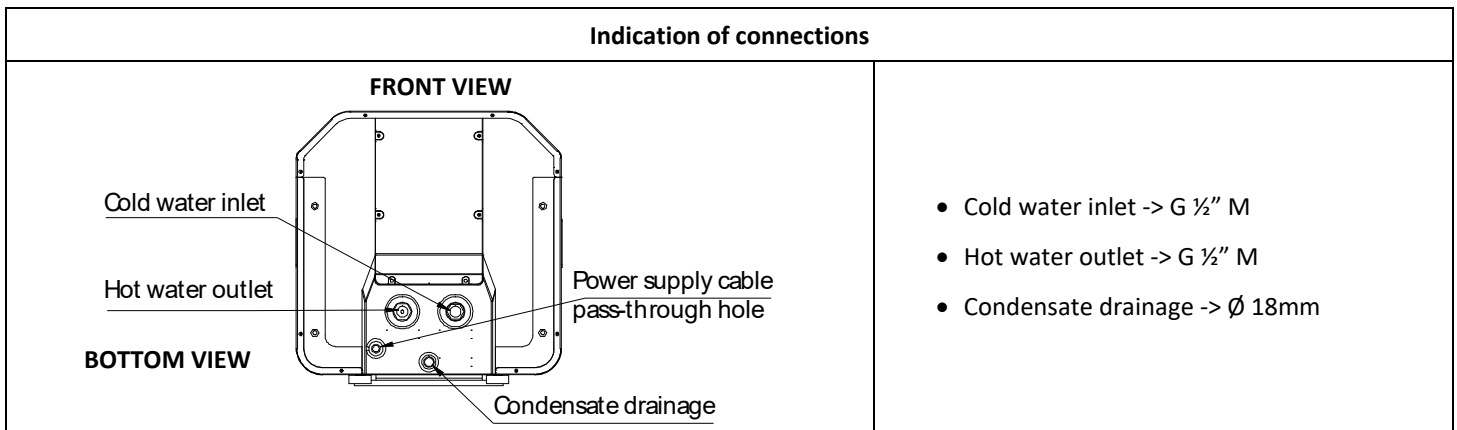

8.2 DIMENSIONS

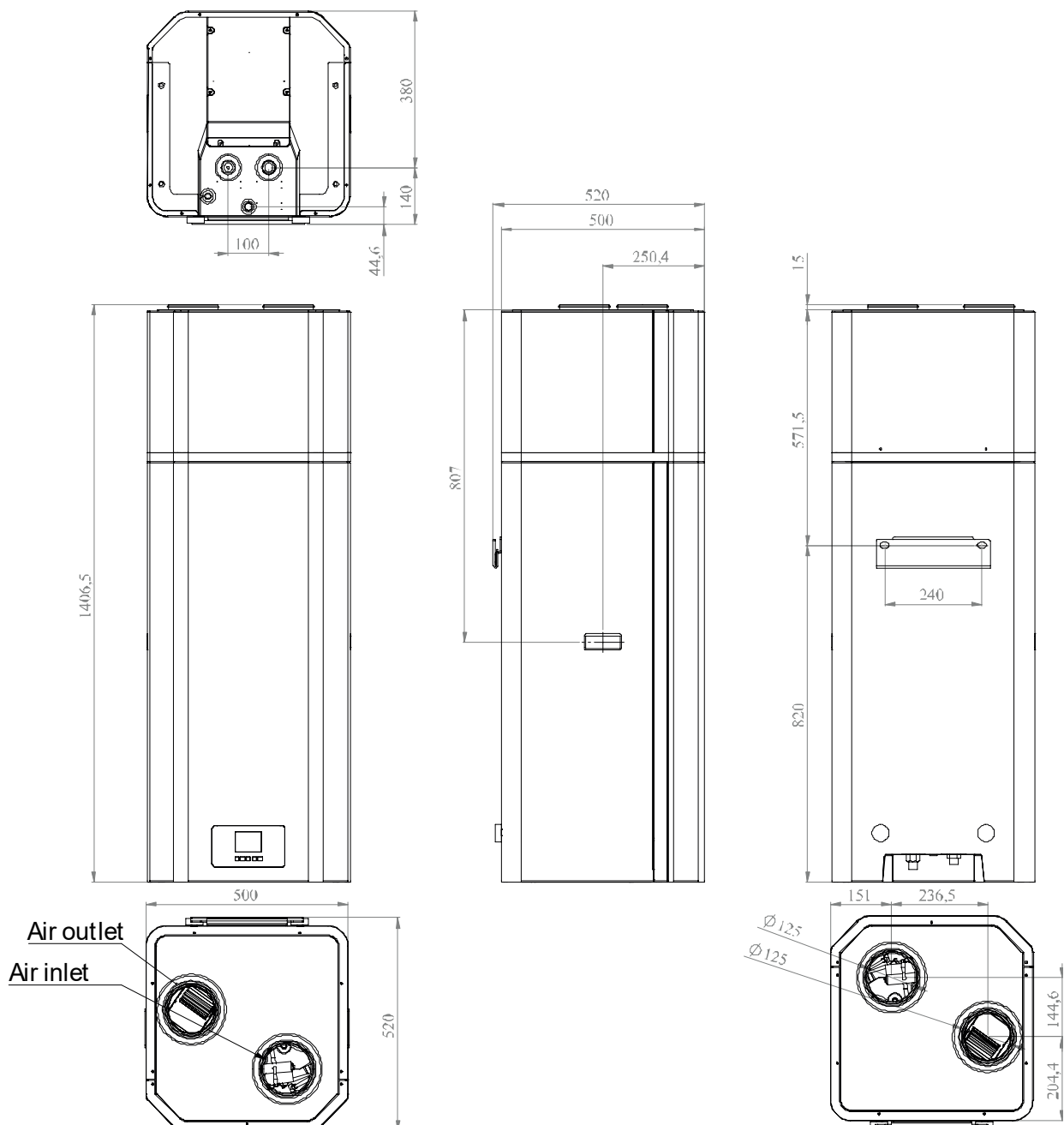

The lower part of the unit is white (RAL9003), and the upper part is light-gray with "orange peel" effect (RAL7035). The same color and the same finishing is replicated in the lower part of the closure.

8.3 ACCESS TO THE FRONT PART

To access the refrigerant circuit and the electrical panel components of the unit, you will need to open the front panel by removing the screws located on the side and then extracting it as indicated in the below picture.

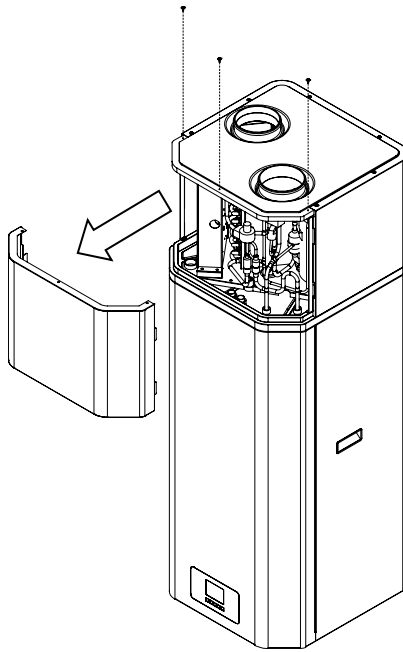

8.4 ACCESS TO THE BOTTOM PART

You need to access to the bottom part of the unit for any eventual control/replacement of the manual reset safety thermostat, electric heater, magnesium anode and for the wiring of the remote switch ON-OFF contact.

<p>Twist off the 6 screws that hold the bottom central plate and remove the cover</p>	<p>1. Manual reset thermostat 2. Electric heater and magnesium anode</p>

8.5 HOW TO REPLACE THE MAGNESIUM ANODE

The Magnesium anode is an anti-corrosion element. It is assembled in the water tank to avoid the creation of oxide layers inside the tank in order to protect it with the other components. It can help to extend the life-span of the tank.

	<p>Replace the magnesium anode every 6 months, clean it if it is intact but encrusted by limestone.</p>
--	--

- Turn the power of the unit 'OFF' and pull out the plug.
- Drain all the water out of the tank.
- Remove the bottom flange where the magnesium anode and the electric heater are installed.
- Unscrew the old anode from the holder.
- Screw again the flange.
- Recharge the water.



8.6 REGULATION THERMOSTAT OF THE ELECTRIC HEATER

The auxiliary electric heater is equipped with a thermostat for regulation; to access this component, you should remove the bottom cover.

The factory setting is made at its maximum value 85°C; any modification of such value is not recommended as it could produce malfunctions on the legionella cycle control (For such purpose it is required to read carefully the paragraph 11.5.2).

8.7 SCHEMATIC OVERVIEW OF THE WATER AND GAS CIRCUIT

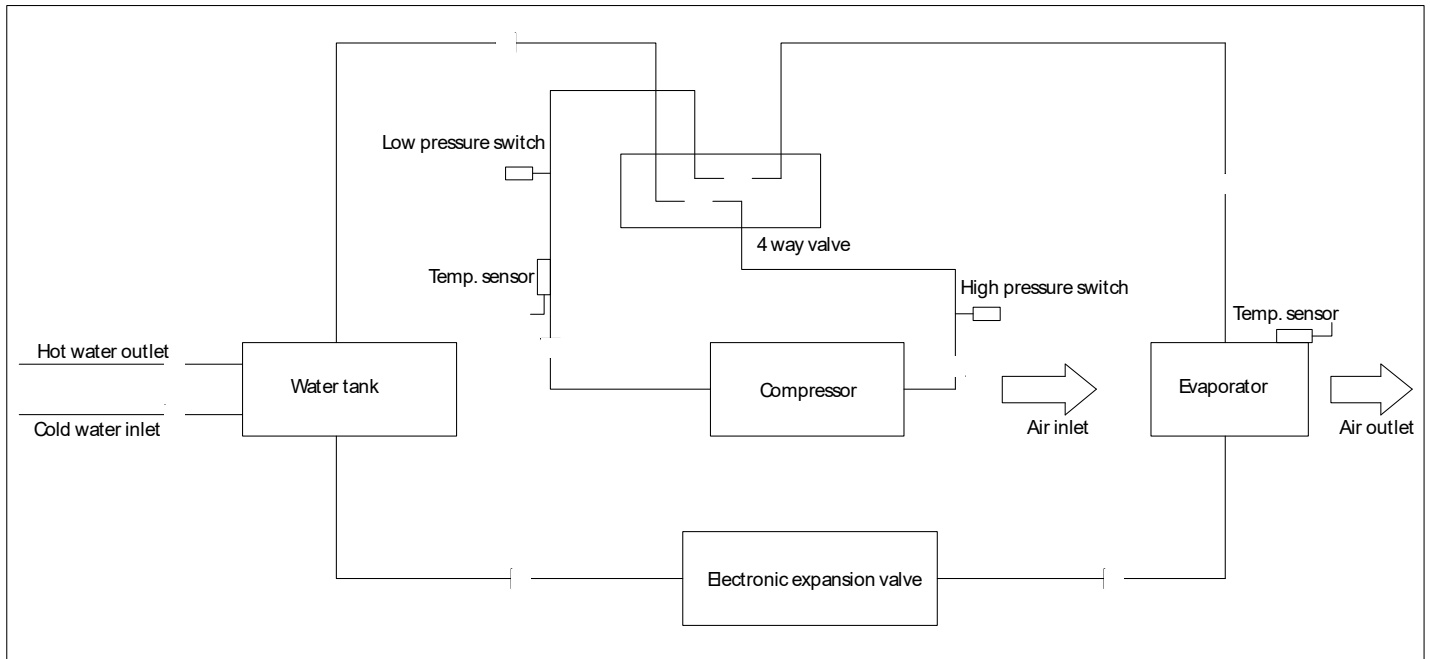

9 INSTALLATION



WARNING: All the operations described below must be carried out only by QUALIFIED PERSONNEL. Prior to any work on the unit, make sure that the power supply is disconnected.

9.1 GENERALITY

When installing or servicing the unit, it is necessary to strictly follow the rules listed in this manual, to conform to all the specifications of the labels stucked on the unit, and to take any possible precautions. Not observing the rules reported on this manual can create dangerous situations.



After receiving the unit, immediately check its integrity. The unit left the factory in perfect condition; any eventual damage has to be questioned to the carrier and recorded on the Delivery Note before signing it.

The company has to be informed, within 8 days, of the extent of the damage. The Customer should prepare a written statement with photographs of any severe damage.



Please note that all the installation diagrams shown in this chapter are only a guide. The correct installation plant must be evaluated case by case by the installer.

9.2 SAFETY INSTRUCTIONS

To prevent injury to the user, other people, or property damage, the following instructions must be followed. Incorrect operation due to ignoring of instructions may cause harm or damage.

Install the unit only when it complies with local regulations, by-laws and standards. Check the main voltage and frequency. This unit is only suitable for earthed sockets, connection voltage 220 - 240 V ~ / 50Hz.





The following safety precautions should always be taken into account:

- be sure to read the following **WARNING** before installing the unit;
- be sure to observe the cautions specified here as they include important items related to safety;
- after reading these instructions, be sure to keep it in a handy place for future reference.

9.2.1 Warnings

	<p>The unit must be securely fixed to avoid noise and shaking: when insufficiently installed, the unit could fall causing injury. The bearing surface should be flat to bear the weight of the unit and suitable for installing the unit without increasing noise or vibrations.</p>
	<p>When installing the unit in a small room, please take measures (like sufficient ventilation) to prevent the asphyxia caused by the leakage of refrigerant.</p>
	<p>Be sure to use the provided or specified parts for the installation work: the use of defective parts could cause an injury due to possible fire, electric shocks, the unit falling etc.</p>
	<p>Do not tear off the labels on the unit: the labels are for the purpose of warning or reminding, keeping them can ensure your safe operations.</p>
	<p>Indoor installation is compulsory: it is not allowed to install the unit at outdoor or rain achieving place and generally accessible from any source of water.</p>
	<p>The installation place without direct sunlight and other heat supplies is recommended: if no way to avoid these, please install a covering.</p>
	<p>Make sure that there's no obstacles around the unit.</p>

9.2.2 Cautions

	<p>Do not install the unit in a place where there is a chance of flammable gas leaks: if there is a gas leak and gas accumulates in the area surrounding the unit, it could cause an explosion.</p>
	<p>Do not clean the unit when the power is 'ON': always shut 'OFF' the power when cleaning or servicing the unit. If not, it could cause an injury due to the high speed running fan or an electrical shock.</p>
	<p>Disconnect the appliance from the power supply by removing the plug from the socket or, by turning off the main switch if installed upstream of the unit.</p>
	<p>Never remove the plug from the socket by pulling out the power cord.</p>
	<p>Do not perform cleaning operations of the machine before turning off the unit, unplugging it or turning off the external switch.</p>
	<p>In case the unit is used without air ejection duct, verify that the installation room has got a volume not less than 10m³, with adequate ventilation. Please note that the temperature of the expelled air is 5-10°C lower than the inlet air, therefore if not channelled it can cause a significant lowering of the temperature of the installation room.</p>
	<p>Do not continue to run the unit when there is something wrong or there is a strange smell: the power supply needs to be shut 'OFF' to stop the unit; otherwise this may cause an electrical shock or fire.</p>
	<p>Inside the unit, there are some moving parts. Be especially careful when working near them, even if the unit is off.</p>
	<p>Do not insert fingers or other objects into the fan and evaporator.</p>
	<p>The temperatures of heads and exhaust piping of the compressor are usually high. Therefore be careful when working near condensing coils.</p>
	<p>The aluminum fins are very sharp and can cause serious injuries.</p>

9.3 HANDLING OF THE UNIT

As a rule, the unit is to be stored and/or handled in its shipping packing box in upright position and should be empty without water charge. During the transport (provided that it is done with care) and the storage, it's advisable to not exceed an inclination angle of 30 degrees (45° for short time). Ambient temperatures for storing is from going -20 to +70 degrees Celsius.

9.3.1 Handling of the unit with forklift

When using the forklift for handling, the unit must remain mounted on the pallet. The lifting rate should be kept to a minimum. Due to its top-heaviness, the unit must be secured against tipping over. To prevent any damage, the unit must be placed on a level surface.

9.3.2 Manual handling of the unit

For the manual handling, the wooden pallet can be used. It's possible to use ropes or carrying straps, taking care to avoid ioverturning the unit. The maximum allowed inclination angle is 45°, the vertical position is advised.

If transport in inclined position (with maximum angle of inclination 45° for shot period of time) cannot be avoided, the unit should be taken into operation one hour after it has been moved into final position.

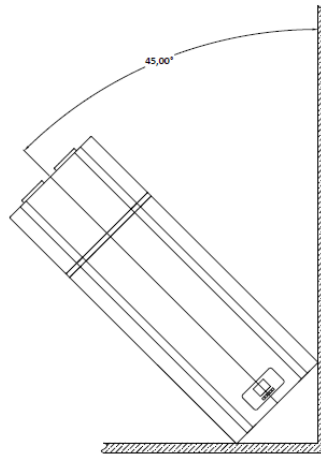

WARNING:

Due to the high center of gravity, low overturning moment, the unit must be secured against tipping over.

The cover of the unit cannot withstand stress, so it cannot be used for transport.

9.4 WALL MOUNTING

Appropriate plugs and support brackets are supplied together with the unit for installation.

1. Proceed to drill holes into the wall of installation. Make sure that the selected wall is adequate to support the unit and there are no water pipes, gas pipes and electricity cables.
2. Insert the supplied rawlplugs in the holes and fix the support bracket through the screws and washers.
3. Secure the mounting bracket of the unit. Make sure that is centered on the wall.
4. Hook up the boiler to the wall by inserting the tab of the metal bracket into the cavity of the wall-mounting bracket fixed to the wall.
5. Make sure that the unit is properly levelled, you should eventually balance the support on the wall by screwing or unscrewing the spacers on the back.

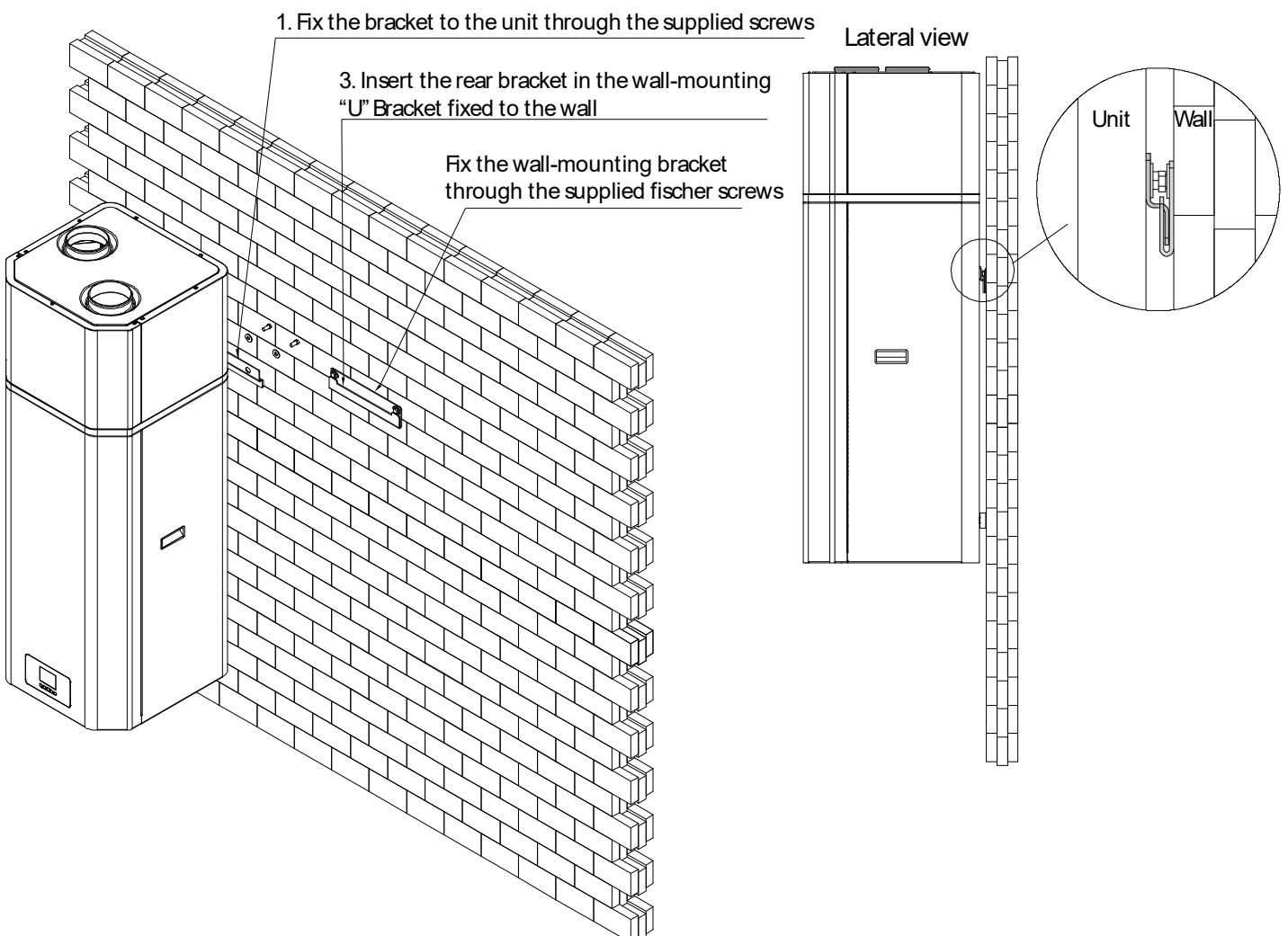

9.5 REQUIRED SERVICE SPACE

Below are reported the required minimum space for service and maintenance tasks on the units. Moreover, re-circulation of discharge air has to be avoided; failure to observe this point will result in poor performance or activation of safety controls. For these reasons it is necessary to observe the following clearances.

	<p><i>If air inlet and/or outlet pipes are connected, portion airflow and capacity in heat pump unit will lose.</i></p>
	<p><i>If the unit connects with air ducts it should be: DN 120 mm for pipes or 120 mm internal diameter flexible hose. The total length of the ducts should not be longer than 8m and the maximum static pressure should not exceed 60 Pa. If the air ducts are bended, the pressure loss will be maximal. So if there are 2 bending pipes, the total length of the ducts should not be longer than 4m.</i></p>
	<p><i>Please note that the performance of the unit are reduced in the case the air inlet is connected to a duct which takes air from outside, because of the low winter temperatures and high summer temperatures. The optimal working ambient temperature is 20°C.</i></p>

Please note that the unit is designed in order that the parts that may require maintenance are accessible from the front part. In any case it is advisable to keep free the encountered spaces on both left and right side in order to facilitate the removal of the unit and maintenance.

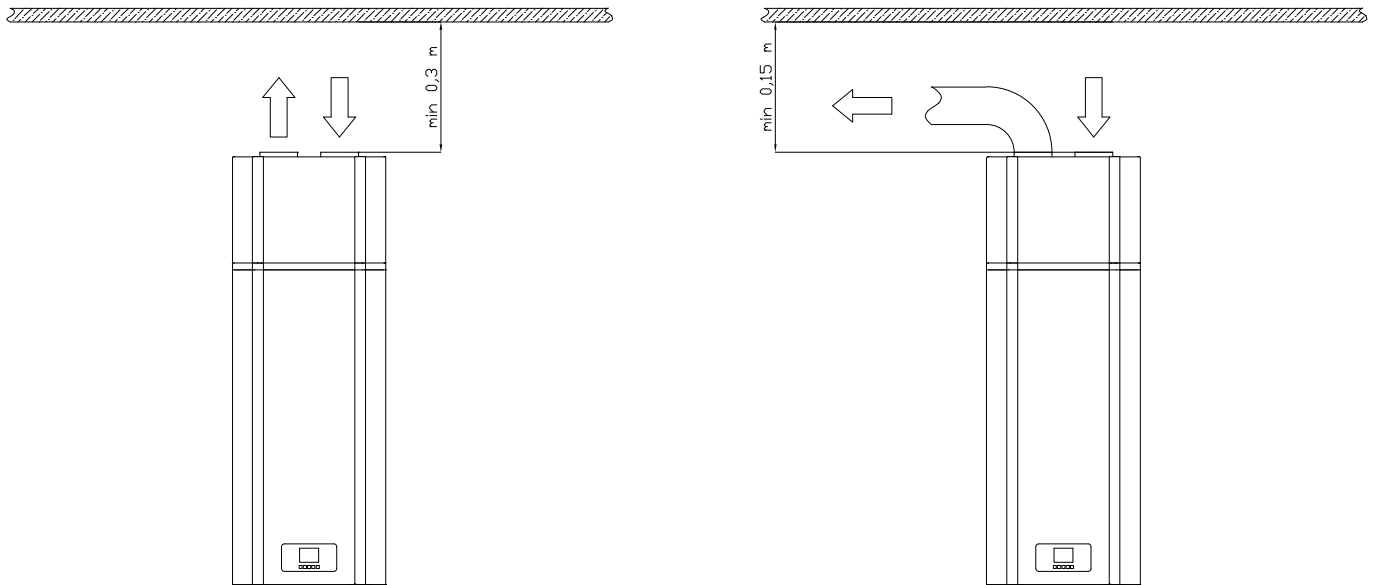

In the right side table are shown the max lengths of air piping that should be respected.

Max length of air piping (in+out)		d = 125mm
Without curves		8 m
90° curves no.	1	6,9 m
	2	5,9 m
	3	4,9 m
	4	4 m

The unit is self-supporting, therefore, it is also possible to install it on the floor using the special anti-vibration feet (NOT supplied with the unit). See the image below.

Vibration damper SUPPORTS for floor installation

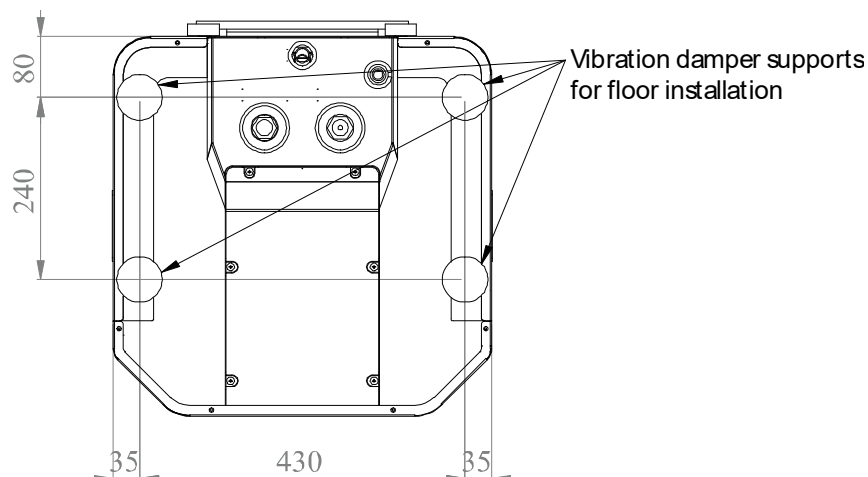

9.6 INSTALLATION OVERVIEW

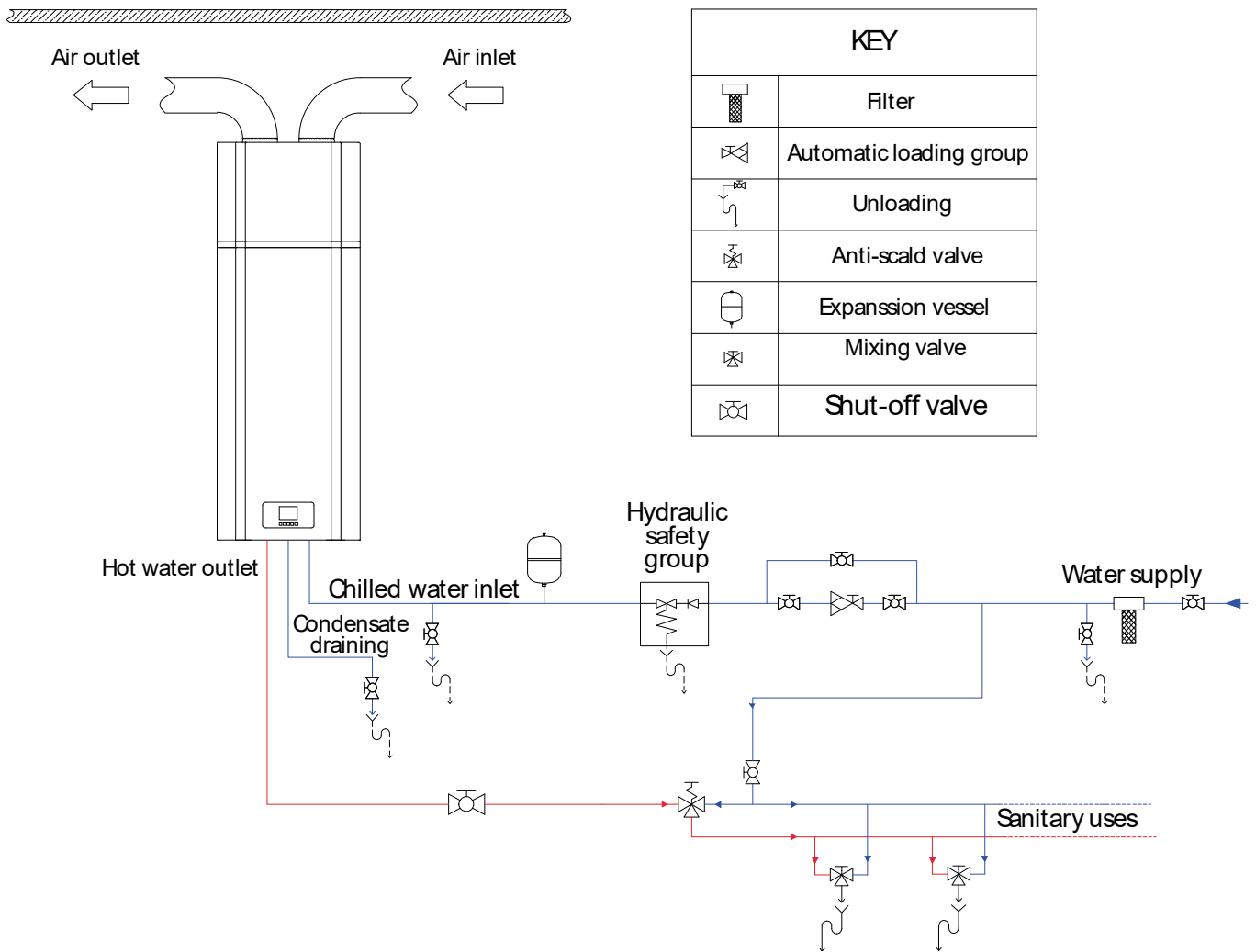

An hydraulic safety group complying with EN 1487 standards must be installed in the water inlet. If not, it could cause damage to the unit, or even hurt people. The safety group must be provided with stop valve, manual drain valve, inspectionable non-return valve and safety valve set to 8 bar. For the installation place please refer to the pipeline connection sketch. The safety group must be protected from frost.

The discharge pipe connected to the safety group is to be installed in a continuously downward direction and in a frost-free environment. Ensure the water may drip from the discharge pipe of the safety group and that this pipe must be left open to the atmosphere.

The safety group is to be operated regularly to remove lime deposits and to verify that it is not blocked. Please beware of burn, because of the high temperature of water.

The expansion tank with capacity suitably sized to absorb volume variations (depending from the extension of sanitary distribution piping) must be installed in the inlet line.

The tank water can be drained through the external manual gate valve installed on the inlet pipe (not provided).

After all the pipes installed turn on the cold water inlet and hot water outlet to fill the tank. When there is water normally flowing out from water outlet taps, the tank is full. Turn off all valves and check all pipes. If any leakage, please repair.

If the inlet water pressure is less than 1.5 bar, a pressure pump should be installed at the water inlet. For ensure the long safety using age of tank at the condition of water supply hydraulic higher than 5.5 bar, a reducing valve should be mounted at the water inlet pipe.

A filter is advisable in the air inlet. If the unit is connected with ducts, filter in there must be put forward to the air inlet of duct.

Make sure that the condensate drain pipe is at the lowest place and make a siphon on it if necessary.



9.7 HYDRAULIC CONNECTIONS

The hydraulic connections have to be done in accordance with national and local regulations. Pipes can be made up of multilayer pipe, polyethylene or stainless steel and must withstand at least 100°C and 10 bar. Pipes have to be designed depending on the desired water flow and on the hydraulic pressure drops of the system. All pipes have to be insulated with closed-cell material of adequate thickness. Units should be connected to piping by means of flexible joints. Piping should include:

- Y-shaped metallic filter (to be mounted on the inlet pipe) with a mesh not larger than 1mm.
- Automatic charging group (3 bar advised) when water supply pressure is higher than 5,5 bar.
- Hydraulic safety group (8 bar).
- Manual gate valves to separate the unit from the hydraulic circuit.
- Manual gate valve on the inlet pipe to discharge the unit if necessary.
- Thermometers for wells to monitor the system's temperature.
- Expansion tanks, safety valves and air vents where indicated in the following installation diagrams.

	<i>Perform the connections making sure that weight of the pipes do not overload the unit.</i>
	<i>Check the water hardness, which should not be below 12°f. With particularly hard water, it's recommended the use of a water softener so that the residual hardness is no more than 20°f and no less than 15°f.</i>
	<i>WARNING: When it's possible, connect the pipes to the hydraulic connections always using the system key against key.</i>
	<i>WARNING: Unit water inlet pipe have to be in correspondence with the blue connection, otherwise the unit malfunction could occur.</i>
	<i>WARNING: It is compulsory to install on the WATER INLET connection a metallic filter with a mesh not larger than 1 mm. Should the filter not be installed, the warranty will no longer be valid. The filter have to be kept clean, so make sure that it is clean after the unit has been installed, and then check it periodically.</i>
	<i>Perform the drainage/piping work according to the installation instruction. If there is a defect in the drainage/piping work, water could leak from the unit and household goods could get wet and be damaged.</i>
	<i>The hot water needs to mix with cold water for terminal usage, too hot water (over 50°C) in the heating unit may cause injury. It's recommended the use of anti-scald valves.</i>

	<i>The diagrams are to be considered only for indication purpose. It is always required the study of the specific installation context and the approval of the system by a qualified heating engineer designer.</i>
---	--

9.7.1 Water connections

Please pay attention to the below points when connecting the water loop pipe:

- 1) Try to reduce the water loop resistance.
- 2) Make sure that there is nothing in the pipe and the water loop is smooth, check the pipe carefully to see if there is any leak, and then pack the pipe with the insulation.
- 3) Install the hydraulic safety group in the water inlet.
- 4) Install also an expansion tank suitably sized to absorb volume variations.
- 5) The nominal pipe diameter must be selected on the basis of the available water pressure and the expected pressure drop within the piping system.
- 6) The water pipes may be of the flexible type. To prevent corrosion damage, make sure that the materials used in the piping system are compatible.
- 7) During the installation of the pipes in situ, any contamination of the piping system must be avoided.

9.7.2 Water loading

If the unit is used for the first time or used again after emptying the tank, please make sure that the tank is full of water before turning on the power.

- 1) Proceed to thoroughly clean the system
- 2) Open the cold water inlet and hot water outlet.
- 3) Start the water loading. When there is water normally flowing out from the hot water outlet, the tank is full.
- 4) Turn off the hot water outlet valve and water loading is finished.

	<i>ATTENTION: Operation without water in water tank may result in damage of auxiliary E-heater.</i>
--	--



9.7.3 Unload of water from the tank

If the unit needs cleaning, handling etc, the tank should be unloaded. It is possible to do this through the water supply inlet connection or through a manual shut-off as recommended at the beginning of the section (the installation of the manual shut-off valve is the user's/installer's responsibility).

- 1) Close the cold water inlet.
- 2) Open the hot water outlet and open the manual valve of drainpipe.
- 3) Start the water unloading.
- 4) After unloading the water, close the manual valve.

9.8 ELECTRICAL CONNECTIONS

Check out that the power supply meets the unit's electric nominal data (tension, phases, frequency) reported on the technical label of the unit. This appliance is fully supplied with a power cord and Schuko plug, it is forbidden to tamper with the power cord or the plug, contact the customer assistance service if necessary. It is recommended to carry out a check of the main electrical circuit and its compliance with the regulations in force. Check that the main electrical circuit is adequate for the maximum power input of the unit (refer to the data on the nameplate) in both the cables section and the compliance with the current legislation.

	WARNING: The power supply have to respect the listed limits: failing this, warranty will terminate immediately. Before any operation on the unit, be sure that the power supply is disconnected.
	WARNING: The supply voltage's fluctuations can not exceed $\pm 10\%$ of the nominal value. Should this tolerance not be respected, please contact our technical department.
	The unit must always have an earthed connection. If the power supply is not earthed, you may not connect the unit.
	Never use an extension cable to connect the unit to the electric power supply.
	If there is no suitable, earthed wall socket available, have one installed by a recognized electrician.
	Do not move/repair the unit by yourself.
	If the supply cord is damaged, it must be replaced by the manufacturer or its service agent or a similarly qualified person in order to avoid a hazard. Improper movement or repair on the unit could lead to water leakage, electrical shock, injury or fire.
	The installation height of the power socket should be over greater than the hydraulic connection point of the unit in order to protect the unit from water that may spatter.

In order to get access to the electrical box:

- 1) remove the front part of the unit, twist off the screws placed on the sides (using a suitable long screwdriver, it is possible to do it frontally to the unit for any built-in installations or very close to the walls)
- 2) remove the metallic cover of the electrical box unscrewing the 4 screws
- 3) the unit is already provided with a power supply cable connected to the electrical box. If it's necessary to disconnect it and to connect a longer cable, or if it's necessary to connect an ON/OFF remote signal, please refer to the wiring diagram.

The specification of the power supply cable is 3*1.5mm². The fuse protection specification is 16A 250V.

There must be a switch when connecting the unit to the power system. The current of the switch is 10A.

A creepage breaker must be installed near the power supply and the unit must be effectively earthed. The specification of the creepage breaker is 30mA, less than 0.1sec.

The remote ON-OFF contact is located in the bottom part of the unit inside the box from which the resistance and the safety thermostat can be accessed. See paragraph 8.4.

10 START UP

Before start-up:

- Check out the availability of the supplied wiring diagram and manual of installed apparatus.
- Check out the availability of the electrical and hydraulic diagram of the plant in which the unit is installed.
- Check out that all water connections are properly installed and all indications on unit labels are observed.
- Check the inlet water pressure, make sure that the pressure is sufficient (above 1,5 bar).
- Check that the shut-off valves of the hydraulic circuit are open.
- Verify that the hydraulic circuit has been charged under pressure and air vented.
- Check if any water flows out from the hot water outlet, make sure that the tank is full of water before turning on the power.
- Ensure that arrangements have been provided to drain the condensate.
- Check out the electric connections.
- Check that electrical connections are carried out according to the norms in force including grounding.
- Make sure that the voltage is within the limits ($\pm 10\%$) of tolerance range respecting the value indicated on the technical label.
- Check out that there is no refrigerant leakage.
- Check out that all the cover panels are installed in the proper position and locked with fastening screws before start up.
- Check the unit; make sure that everything is ok before turning 'ON' the power of the unit, check the light on the wire controller when the unit runs.

- Use the wire controller to start the unit.
- Listen to the unit carefully when turning 'ON' the power of the unit. Turn the power 'OFF' when you hear an abnormal sound.
- Measure the water temperature, to check the undulation of the water temperature.
- Once the operation parameters have been set (only by qualified person, you cannot do it by yourself), the user cannot change the parameters optionally. Please contact a qualified service person for setting parameters if it is necessary.



WARNING: Never switch off the unit (for a temporary stop) by switching off the main switch: this component should be used to disconnect the unit from the power supply only for long stoppages or maintenance/repairing operations.

WARNING: Do not modify the internal wiring of the unit otherwise the warranty will terminate immediately.

11 APPLIANCE OPERATION

11.1 USER INTERFACE

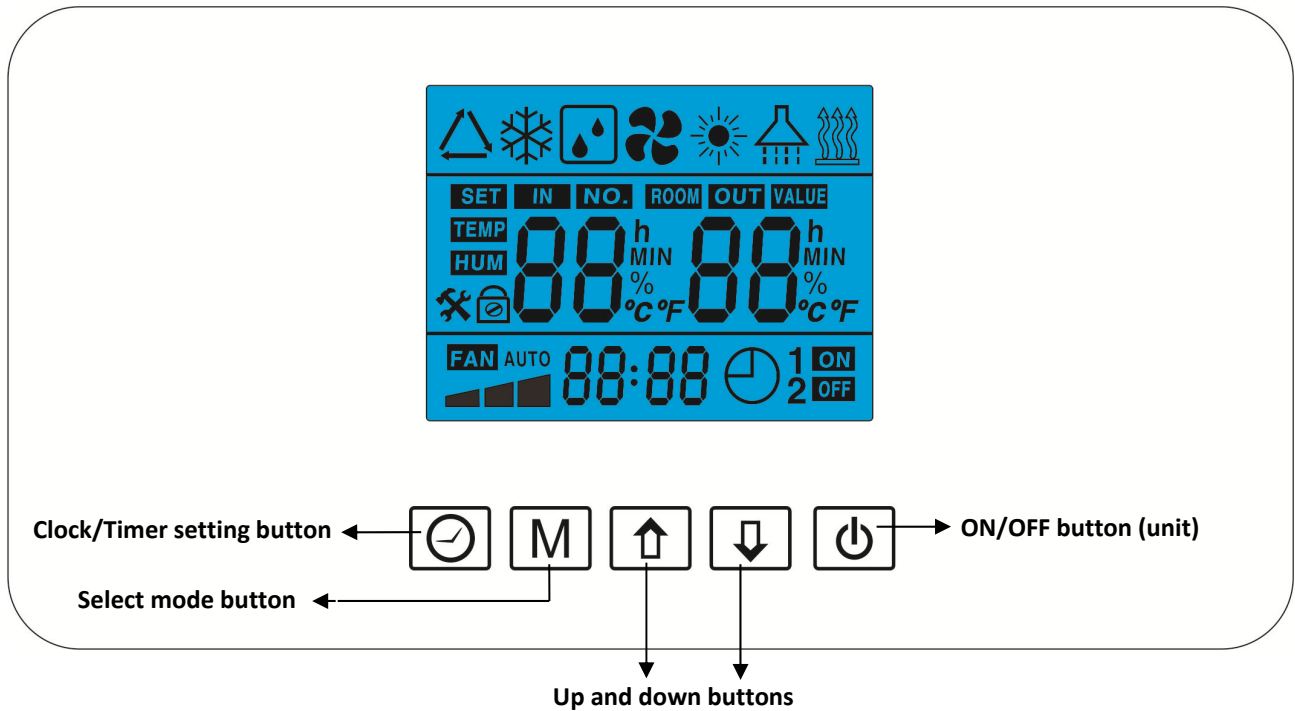

11.2 OPERATION

1. Power 'ON'

When turning 'ON' the power, the whole icons will be displayed on the controller screen for 3 seconds. After checking if everything is ok, the unit enters into standby mode. Water temperature value and clock time are displayed on the screen.





2. ON/OFF button

In standby mode if you press this button for 3 seconds, the unit will start operation in accordance with the setting mode. The running mode, set temperature and water temperature, clock time and timer situation will be displayed on the screen.

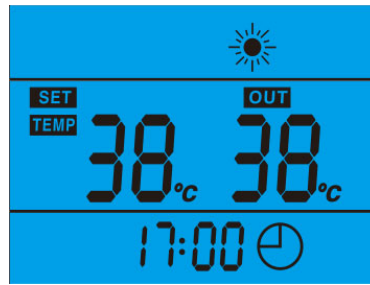
When the unit is in operation and if you press this button for about 3 seconds, it will enter in standby mode. Press the same button to exit from parameters reading mode or to check the status of the unit.







3. and buttons

- These are multi-function buttons. They are used for setting of temperature, parameters, and for clock and timer adjustments.
- During the running status of the unit, use  and  buttons for direct adjustment of the setting temperature.
- Use these buttons when the unit is in the status of clock setting, to adjust the hour(s) and minute(s) of the clock time.
- Use these buttons when the unit is in the status of timer setting, to adjust the hour(s) and minute(s) of the timer 'ON'/'OFF' program.













4. Clock button

Clock setting:

- Press this button to enter in the clock setting interface: hour indicator "88:88" flashes;
- Press the  and  buttons to set the exact hour(s) and press the clock button for confirmation: minute indicator "88:88" flashes;
- Press the  and  buttons to set the exact minute(s) and press the clock button to confirm and exit.

The adjust clock time is displayed.

Timer setting:

- Press the clock button for 5" to enter into the timer setting interface: timer 'ON' hour icon "88:88" flashes to set the time of starting operation;
- Press the  and  buttons to set the hour and press the clock  button to confirm: the timer 'ON' minute icon "88:88" start flashing;
- Press the  and  buttons to set the minutes and press the clock button  to confirm: the timer 'OFF' hour icon "88:88" start flashing;
- Press the  and  buttons to set the hour and press  to confirm: the timer 'OFF' minute icon "88:88" start flashing for timer off setting.
- Press the  and  buttons to set the minutes and press  to confirm the activation of the 'ON' and then press the clock button to quit the timer setting mode.

The timer "ON" and timer "OFF" icons will be displayed near the current clock time.

The settings of the timer are repeated cyclically and are still valid even after a power failure.

To reset the timer settings, enter the setting and adjust the values 00:00 for timer on/off.

Press the clock button for 3 seconds to lock the display, however the buttons will unlock automatically after 30 seconds of inactivity in the display. Press the clock button for 3 seconds to unlock again the display.

5. Mode button

This button allows you to select the operating mode, and also to control and configure a series of allowed parameters.

- 1) When the unit is in operation, press this button to select the desired mode; for the different available modes, see paragraph 11.4. Each time you select a certain mode, you will shift to the next one and the relative icon will be ON (see paragraph 11.4.6)
- 2) Input of parameters:
 - Press this button for 5 seconds in order to access the user parameters control.
 - Use the scroll buttons to input the various parameters.
 - Press the start button to exit.
 - If the unit doesn't start operation within 30 seconds, the controller will exit and saves automatically the settings.

Some parameters can be set by the user/installer (the password to use for modification is **24**), while those of operation are locked through a non-disclosable passwords. Only a qualified technician of the manufacturer is able to get access and to modify the operation parameters.

6. Error codes

During standby or running status, if there is a malfunction, the unit will stop automatically and show the error code in the middle of the controller display.

11.3 LCD icons

1. Available hot water

The icon indicates that the domestic hot water temperature reaches the set point. The hot water is available for use. Heat pump is standby. It is possible that the temperature shown on the display is 1°C lower than the set temperature since the displayed temperature is that of the bottom part of the tank. However the achievement of the setting value is ensured.

2. Fan function

The icon indicates that the fan function is enabled.

3. Electrical heating

The icon indicates that the electrical heating function is enabled. The electrical heater will work according to the control program. The icon flashes during a disinfection cycle.

4. Defrosting

The icon indicates that the defrosting function is enabled. This is an automatic function, the system will entry or exit the defrosting according to the inner control program. The defrosting parameters cannot be changed in the proper place and the unit is not equipped with the manual defrost control.

5. Heating

The icon indicates that the current operation mode of the system is heating by the heat pump.

6. Heating and electric heater

The presence of both icons indicates that the heat pump and the electric heater are both in operation.

7. Key lock

The icon indicates the key lock function is enabled. The keys cannot be operated until this function is disabled.

8. Left zone display temperature

The display shows the setting water temperature.

When checking or adjusting the parameters, this section will display the relating parameter number.

9. Right zone display temperature

The display shows the current top part part temperature of the water tan.

When checking or adjusting the parameters, this section will display the related parameter value.

In case of malfunction, this section will display the related error code.

10. Time display

The display shows the clock time or timer time.

11. Timer 'ON'

The icon indicates that the timer 'ON' function is enabled.

12. Timer 'OFF'

The icon indicates that the timer 'OFF' function is enabled.

13. Error

The icon indicates that there is a malfunction, associated the error code in the right side of the display.

11.4 MAIN LOGICS OF OPERATION

Some presetting for operation are included in the control panel, choose from the list the one that is more desired for operating the unit.

11.4.1 Auto mode

First priority is given to the operation through the heat pump system and then the electric heater acts only if necessary or in case of malfunction when the unit reaches the maximum or minimum allowable operating limit pressure. You can select a temperature in the range of 38°C ÷ 60°C, by default the temperature is set at 50°C.

11.4.2 Green mode

In this mode, the operation is only carried out by the heat pump, while the electric heater acts in case of malfunction when the unit reaches the maximum or minimum allowable operating limit pressure.

11.4.3 Boost mode

This mode involves the management of the joint operation of both heat pump and electric heater systems. You can select a temperature in the range of 38°C ÷ 70°C, by default the temperature is set at 50°C.

11.4.4 E-heater mode





In this mode, the operation is only carried out by the electric heater. You can select a temperature in the range of 38°C ÷ 70°C, by default the temperature is set at 50°C.

11.4.5 Fan Mode

In fan mode, both heat pump and electric heater are off and can work only the fan motor at high speed whereas the antifreeze function remains active.

11.4.6 Operation icons

During the selection, the relative mode icons will light up after the selection.

Auto mode	Green mode	Boost mode	E-heater mode	Fan mode
				

11.5 AUXILIARY CONTROL LOGICS

11.5.1 Thermal protections

First step protection: when the tank water goes up to 80°C, the unit will stop and the corresponding error code (E03) will appear on the controller display. This is an auto-reset protection. When tank water temperature goes down, the unit can start again.

Second step of protection: in case of first step failure, when the water temperature of the tank becomes equal or higher than 85°C, the electrical heater stops, unless the protection is manually reset.

For the manual reset of the protection, remove the bottom cover and press the red button of reset on the thermostat.

11.5.2 Disinfection weekly cycle (Anti-legionella)

The unit is programmed to activate a weekly anti-Legionella cycle that brings the tank water at a temperature of 70°C. This system allows to reduce the risk due to bacteria that causes various diseases, commonly known as "Legionella". It 's recommended to read this paragraph and to ask explanations to your installer/plant designer in order to be properly informed about the risk of spreading this disease. We strongly advised you to read the "Guidelines for prevention and control of legionnaires' disease - Approved in the State-Regions Conference of May 7, 2015- Italy and subsequent amendments, which must be taken as a reference for designing the plant.

The operation of the disinfection cycle is as follows:

The heater will start each week at the setting time (parameter 13) automatically, regardless if the machine is **ON** or in standby mode (i.e. the unit is off but remains connected to the power supply)

When the upper tank temperature (TS3) becomes higher than the values set by the parameter 4 (by default set at 70°C, the user is not allowed to change this value), the electric heater stops. When the previous temperature decreases below TS3-1°C and TS3 for the set disinfection time (parameter 5, by default 30 minutes and cannot be changed by the user), therefore the unit quits the disinfection cycle.

When parameter 5 is set to be 0, the disinfection function is disabled (user cannot set it).

The control logic program starts to calculate the duration of the cycle when the temperature of the water tank reaches the value of TS3. The icon shown below blinks during the anti-legionella cycle.

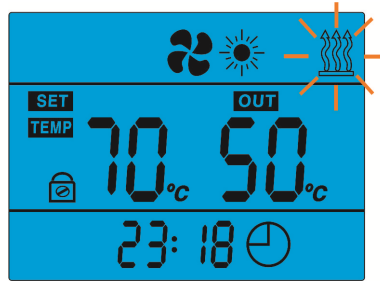

If the unit is in standby mode (and also if ON/OFF contact is opened), the disinfection occurs with the same control logic in case of the unit is in operation.

	<p><i>If the unit is disconnected from the power supply, the disinfection cycle will not occur. If the unit is left without power supply for longtime, DO NOT use the water contained inside. It is recommended to empty the tank and the water contained inside the pipes of the DHW system. It is also recommended that you let the water flowing for enough time across the pipes not only for renewing all the water but also for washing the pipes themselves. This required "washing" time is inversely proportional to the temperature of the water flowing in the pipes. After cleaning and renewing all the water contained inside the unit and in the pipes of the system, you should proceed with a disinfection.</i></p>
	<p><i>The disinfection cycle happens only in water tank. Therefore, it's recommended to perform a recirculation of the water system especially for disinfecting all the contained water. If cannot be possible, according to the preceding warning, it is recommended to let the water system to flow for a enough for cleaning the pipes and renewing the water.</i></p>
	<p><i>If the parameter 5 is set to be 0, the disinfection function is disabled. Such operation is strictly unrecommended; the manufacturer declines any responsibility for the data caused by a lack or incorrect unit disinfection. If you desire to disable the disinfection cycle, you should ask the maintainer about the consequences that may arise from this operation</i></p>
	<p><i>It is strictly forbidden to change the default value of parameter 4. The parameters 4 and 5 control the anti-legionella cycle (temperature versus time). We recommend to respect the above guidelines, if you want to change them. Please remember that to keep the temperature of the tank water between 55-60°C in order to inhibit the bacterial proliferation (see Annex 13 of the guidelines mentioned above). The plant designer must keep in mind the legionella risk and should adopt all the measures for prevention and control of water.</i></p>
	<p><i>The user is RESPONSIBLE to periodically check the correct operation of the anti-legionella cycle and to verify that during the disinfection, the setting temperature parameter is put to be 4 and is reached for the duration indicated by the parameter 5.</i></p>

11.5.3 ON/OFF contact

When ON/OFF contact is closed, and the controller is ON, the unit can work and the running mode is decided by the setting of the controller.

When ON/OFF contact is closed, but the controller is OFF, the unit can't work.

When ON/OFF contact is opened, but the controller is ON, the unit can't work.

If the controller is ON, and the ON/OFF status is changed from opened to closed, the unit will work by the previous settings of the controller (auto-restart).

If the unit was previously in stand-by, in case the ON/OFF status is changed from opened to closed, the unit remains in stand-by.

For setting the signal remotely, the parameter 17 must be adjusted to be 0 (default). The temperature setting is depending on the parameter 20:

- P.20 = 0 (default), the temperature value introduced manually is compared with the maximum admissible temperature value given by the climatic curve (which is eventually corrected by the compensation parameter P.19), and then the unit will operate according to the lowest one of the comparison between both values.
- P.20 = 1, the setting temperature will be the same as the one introduced manually on the unit.

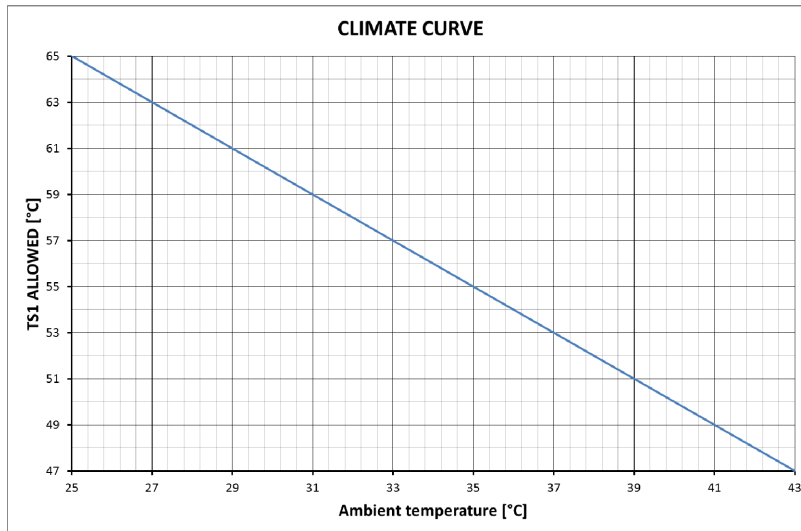

11.5.4 Contact for photovoltaic plant integration

The ON/OFF contact can be configured so that a photovoltaic plant, in max production periods, can be used to obtain the max value of hot water by the unit (set the parameter 17 to be 1). When the contact is closed (activation by FV plant), the tank setting temperature TS1 is increased to the max possible value, according to the settings of the parameter P.20.

- P.20 = 0 (default), the temperature value introduced manually is compared with the maximum admissible temperature value given by the climatic curve, and then the unit will operate according to the highest one of the comparison between both values.
- P.20 = 1, the setting temperature will be equal to (65°C).

11.5.5 Defrosting cycle

Especially when the unit works when the outside temperature is very low, frost may appear on the evaporator. In this case the defrost process is activated and the relative LED icon flashes.

11.5.6 Anti-freeze protection

If the unit is switched off but still under voltage, and the tank temperature drops below 5°C; the electric heater is forced to work until reaching the same temperature at 10°C. In this case the error code "P06" will appear on the display of the unit.





11.6 PARAMETERS' CONTROL AND SETTING

The parameters can be displayed on the screen. Certain user/installer parameters can be changed directly, while the others can be displayed but only authorized technicians can access with password to to modify them. Below is given the list of the parameters.

 **Once the parameters have been set by the installer, it is not recommended for the user to modify them. Please contact a qualified person for modifying the setting values of the parameters.**

Parameter nr.	Description	Range	Default	Notes
A	Lower tank temperature sensor	-20 ~ 99°C	In case of lower tank temp. sensor failure, the error code "P01" will be displayed.	
B	Upper tank temperature sensor	-20 ~ 99°C	In case of upper tank temp. sensor failure, the error code "P02" will be displayed.	
C	Evaporation temperature sensor	-20 ~ 99°C	In case of evaporation temp. sensor failure, the error code "P03" will be displayed.	
D	Compressor suction temperature sensor	-20 ~ 99°C	In case of compressor suction temperature sensor failure, the error code "P04" will be displayed.	
E	Room temperature sensor	-20 ~ 99°C	In case of room temperature sensor failure, the error code "P05" will be displayed.	
F	EXV open steps	100 ~ 470 step	Not adjustable	
01	ΔT compared to the compressor restart setting temperature.	2 ~ 15°C	5°C	Adjustable
02	Reserved			
03	Reserved			
04	Weekly disinfection temperature	50 ~ 70°C	70°C	Only technician of "TAC" can change it.
05	Holding time of the disinfection temperature	0 ~ 90 min	30 min	Only technician of "TAC" can change it.
06	Defrosting cycle time duration	30~90 min	45 min	Only technician of "TAC" can change it.
07	Outside temperature of defrost cycle initialization	-30 ~ 0°C	-7°C	Only technician of "TAC" can change it.
08	Defrosting termination temperature	2 ~ 30°C	20°C	Only technician of "TAC" can change it.
09	Maximum defrosting cycle time	1 ~ 12 min	8 min	Only technician of "TAC" can change it.
10	Operating mode of the electronic expansion valve.	0 (auto) 1 (manual)	0	Only technician of "TAC" can change it.
11	Superheat setting value	-9 ~ 9°C	5°C	Only technician of "TAC" can change it.
12	Steps for manual adjustment of the electronic expansion valve	10 ~ 47 step	35 step	Only technician of "TAC" can change it (N*10)
13	Time to start a disinfection cycle	0~23	23	Adjustable (hours)
14	ΔT for electric heater initialization	2 ~ 20°C	7°C	Adjustable
15	Compressor cumulative operation Time	10 ~ 80 min	30 min	Only technician of "TAC" can change it.
16	Increase of the lower tank temperature	0 ~ 20°C	2°C	Only technician of "TAC" can change it.
17	ON/OFF	0 (From remote signal) 1 (from photovoltaic system)	0	Adjustable
18	Room temperature update period.	2 – 120 min	15 min	Adjustable
19	Compensation temperature for the climatic curve.	-10 – 10 °C	0 °C	Adjustable
20	Type of temperature set control.	0 (set by TS1) – 1 (65°C)	0	Adjustable

Procedure for changing the parameters values that are allowed to the user/installer:

- Press the clock and down arrow buttons (+) simultaneously for 3 seconds.
- "00" will flash on the right side of the display.
- Press the button , the only the first zero "00" will start flashing; use the up/down buttons to select the first value.
- Press again the button M, the other zero "00" will start flashing and select the next value, use the button M to confirm.
- The first parameter with the relative value will flash. At this point, only the parameters defined as "Editable" in the reported table of parameters will be displayed and can be selected.
- Use the **up** and **down** arrow buttons to go to the parameter you want to modify and press the button "M" again to enter the mode of changing the value. Only its proper value will start to flash. Change the value with the up and down arrow buttons and press rge button M to confirm the new value.
- Quit the edit mode by pressing the ON/OFF button .
- The password used view the editable parameters is 24.

11.7 MALFUNCTIONING OF THE UNIT AND ERROR CODES

When an error occurs or the protection mode is set automatically, the circuit board and the wired controller will both display the error message.

Protection/ Malfunction	Error code	LED indicator	Possible reasons	Corrective actions
Standby		Dark		
Normal running		Bright		
Lower tank water temp. sensor failure	P01	☆● (1flash 1 dark)	1) The sensor open circuit 2) The sensor short circuit	1) Check the sensor connection 2) Replace the sensor
Upper tank water temp. sensor failure	P02	☆☆● (2 flashes 1 dark)	1) The sensor open circuit 2) The sensor short circuit	1) Check the sensor connection 2) Replace the sensor
Evaporator coil temp. sensor failure	P03	☆☆☆● (3 flashes 1 dark)	1) The sensor open circuit 2) The sensor short circuit	1) Check the sensor connection 2) Replace the sensor
Return gas temp sensor failure	P04	☆☆☆☆● (4 flashes 1 dark)	1) The sensor open circuit 2) The sensor short circuit	1) Check the sensor connection 2) Replace the sensor
Ambient temp. sensor failure	P05	☆☆☆☆☆● (5 flashes 1 dark)	1) The sensor open circuit 2) The sensor short circuit	1) Check the sensor connection 2) Replace the sensor
Antifreez protection failure	P06	☆☆☆☆☆☆☆☆☆☆● (10 flashes 1 dark)		
High pressure protection (HP Switch)	E01	☆☆☆☆☆● (6 flashes 1 dark)	1) Too high air inlet temp 2) Less water in the tank 3) The electronic expansion valve assembly blocked 4) Too much refrigerant 5) The HP switch damaged 6) The uncompressed gas is in refrigerant system	1) Check if the air inlet temp is over the working limit 2) Check if the tank is full of water. If not, charge water 3) Replace the electronic expansion valve assembly 4) Discharge some refrigerant 5) Replace a new switch 6) Discharge and then recharge the refrigerant
Low pressure protection (LP Switch)	E02	☆☆☆☆☆☆● (7 flashes 1 dark)	1) Too low air inlet temp 2) The electronic expansion valve assembly blocked 3) Too less refrigerant 4) The LP switch damaged 5) The fan assembly can not work	1) Check if the air inlet temp is over the working limit 2) Replace the electronic expansion valve assembly 3) Charge some refrigerant 4) Replace a new switch 5) Check if the fan working when the compressor working. If not, some problems with the fan assembly
High temperature protection (Automatic thermostat T80°C Switch)	E03	☆☆☆☆☆☆☆☆● (8 flashes 1 dark)	1) Too high tank water temp 2) The T85°C switch damaged	1) If the tank water temp is over 80°C, the switch will open and the e-heater will stop for protection. When water temperatures becomes normal, the protection is auto-reset 2) Replace a new switch
Compressor protection	PA	☆☆☆☆☆☆☆☆☆☆● (9 flashes 1 dark)	The compressor is operating out of the air and/or water temperature limits	Wait for the air temperature to become normal for operation.
Defrosting		☆☆☆☆☆☆☆☆ (Flashes in a continuous fashion)		Wait the termination of the defrosting cycle
Communication failure	E08	Bright		

12 MAINTENANCE AND PERIODICAL CONTROLS

	<p>WARNING: All the operations described in this chapter HAVE TO BE CARRIED OUT BY TRAINED STAFF ONLY. Before any operation or before entering the inner components of the unit, be sure that the power supply is disconnected. The compressor's head and discharge piping are usually at high temperature levels. Be very careful when operating in their surroundings. Aluminium coil fins are very sharp and can cause serious wounds. Be very careful when operating in their surroundings. After maintenance operations, re-install the cover panels, and fix them by means of screws where necessary.</p> <p>WARNING: The unit should be installed so that adequate clearance is available for maintenance and repair. The warranty does not cover costs related to platforms or handling equipment necessary for any maintenance.</p>
	<p>The refrigerant circuits must not be filled with different gas other than that indicated on the nameplate. The use of a different refrigerant can cause severe damage to the compressor.</p> <p>It's forbidden to use oils other than those specified in this manual. The use of a different oil can cause serious damage to the compressor.</p>
	<p>It is recommended to set a lower temperature to decrease the heat release, prevent scale and save energy if the outlet water is sufficient.</p>

It is a good rule to carry out periodic checks in order to verify the proper operation of the unit:

OPERATION	1 month	4 months	6 months
Check the water supply and air vent frequently, to avoid lack of water or air in the water loop. Be sure that the tank is always filled with water.	x		
Check out that safety and control devices work correctly.	x		
Check out possible oil leakage from compressor.	x		
Check out possible water leakages from the hydraulic circuit.	x		
Check out the proper working of the external flow switch (if it is installed).	x		
Clean the metallic filters of the hydraulic circuit to keep a good water quality. Lack of water and dirty water can damage the unit.	x		
Clean the finned coil of the heat exchanger by means of compressed air (it's recommended to keep the unit in a place where it is dry and clean, and which has good ventilation).	x		
Check the correct operation of the electric heater for the purpose of anti-Legionella cycle(*). Be sure to make a diagnosis with samples of water taken from the critical points the whole hydraulic circuit.		x	
Check out that all the terminals on the electric board as well as on the terminals of the compressor are properly fixed.		x	
Make sure the electrical components are good. If there is a damaged part or a strange smell, please replace it in time.		x	
Tightening of water connections.		x	
Keep the unit clean by means of soft damp cloth.		x	
It is recommended to clean the tank and e-heater regularly to keep an efficient performance.		x	
Clean regularly any covering grill of the external air duct in order to keep an efficient performance.		x	
Correct voltage.			x
Correct absorption.			x
Check each part of the unit and the pressure of the system. Replace the defect part if there is any, and recharge the refrigerant if it is required.			x
Check the operating pressure, and superheat and subcooling			x
Check of the efficiency of circulation pump.			x
If the heat pump is not used for a long time, please drain out all the water from the unit and seal the unit to keep it good. Please drain the water from the lowest point of the boiler to avoid freezing in winter. Water recharge, disinfection and complet inspection on the heat pump is required before it is restarted.			x
Check and if necessary replace the magnesium stick.			every year

(*) Checking the correct operation of the electric heater: To check the activation of the electric heater, select E-heater and check the rising of the tank water temperature.

12.1 ENVIRONMENTAL PROTECTION

According to the norms dealing with the use of depleting stratospheric ozone substances, it is forbidden to release refrigerants fluids in the atmosphere. They have to be collected and delivered to the seller or to proper gathering points at the end of their operating life. Refrigerant R134A is mentioned among controlled substances and for this reason it has to be subjected to the mentioned norms. **A particular care is recommended during service operations in order to reduce as much as possible any refrigerant loss.**

	<p>This equipment contains R134a refrigerant in the amount as stated in the specification. Do not vent R134a into the atmosphere: R134a, is a fluorinated greenhouse gas with a Global Warming Potential (GWP) = 1430. It should only be serviced or dismantled by professional trained personnel.</p>
--	---

13 TROUBLESHOOTING

This section provides useful information for diagnosing and correcting certain troubles which may occur. Before starting the troubleshooting procedure, carry out a thorough visual inspection of the unit and look for obvious defects such as loose connections or defective wiring.

Before contacting your local dealer, read this chapter carefully, it will save you time and money.



When carrying out an inspection on the electrical box of the unit, always make sure that the main switch of the unit is switched 'off'.

The guidelines below might help to solve your problem. If you cannot solve the problem, consult your installer/local dealer.

- No image on the controller (blank display). Check if the main power is still connected.
- One of the error codes appears, consult your local dealer.
- The scheduled timer does work but the programmed actions are executed at the wrong time (e.g. 1 hour too late or too early). Check if the clock and the day of the week are set correctly, adjust if necessary.

14 DISPOSAL REQUIREMENTS

Once the unit is arrived at the end of its life cycle and needs to be removed or replaced, the following operations are recommended:

- the refrigerant must be recovered by trained people and sent to proper collecting centre;
- compressors' lubricating oil has to be collected and sent to proper collecting centre;
- the casing and various components, if no longer serviceable, must be dismantled and divided according to their nature, particularly copper and aluminium, which are present in conspicuous quantity in the unit.

These operations allow the easy material recovery and recycling process, thus reducing the environmental impact.

The user is responsible of the proper disposal of this product, according to national regulations in the country of destination of the appliance. For more information, please contact the installation company or local competent authority.

	<p><i>An incorrect decommissioning of the appliance may create serious environmental damage and endanger people's safety. Therefore, it's recommended that the unit shall be disposed only by authorized persons and technical training who have followed training courses recognized by the competent authorities.</i></p>
	<p><i>It is required to follow the same precautions described in the previous paragraphs.</i></p>
	<p><i>Pay special attention during the disposal operation of the refrigerant gas.</i></p>
	<p><i>The illegal disposal of the product by the end user leads to the application of the penalties in accordance with the law in the country where the disposal takes place.</i></p>
	<p><i>The crossed bin symbol applied on the appliance indicates that the product, at the end of its useful life, must be collected separately from other wastes.</i></p>

15 TECHNICAL CHARACTERISTICS

TECHNICAL DATA		CALIDO 110
Power supply	V/Ph/Hz	220-240/1/50
Water tank real capacity	L	110
Heating capacity	W	850* (+1500**)
Rated power input	W	236* (+1500**)
Nominal current	A	1.14* (+6.5**)
SCOP _{DHW} (ERP) ***	W/W	3.01
Max power input	W	400 (+1500**)
Max current	A	1.81 (+6.5**)
Heating time with cold tank ***	h:min	6:53
Potenza assorbita in stand by (***)	W	13.4
Max. outlet water temperature (without E-heater operation)	°C	60
Max water temperature **	°C	70**
Minimum temperature for starting	°C	10
Working ambient temperature	°C	-5 ~ +43
Refrigerant max. discharge pressure	bar	25
Refrigerant max. suction pressure	bar	0,2
Refrigerant type		R134a
Refrigerant GWP		1430
Refrigerant charge	g	650
Amount fluorinated greenhouse gases	tCO ₂ eq	0,93
Compressor	Type	Rotary
	Oil (type)	68HES-H
	Oil (q.ty)	376 ml
Fan motor	Type	AC
	W	20
Nominal air flow	m ³ /h	300
Available static pressure	Pa	60
Air flow at 60 Pa	m ³ /h	170
Duct diameter	mm	DN 125
Max allowed pressure water side	bar	6
Relief valve setpoint (to install externally)	Bar	8
Material of of the inner surface of the tank		S235JR with double-layer vitrification
Auxiliary electric heater	kW	1.5
Electronic expansion valve		si
Magnesium anode		si
Material of the heat pump exchanger (condenser)		Copper
Chilled water input	inch	G 1/2 " male
Hot water outlet	inch	G 1/2 " male
Condensed water outlet		Flexible plastic tube Φ18 mm
Drainage	inch	To be installed externally
Power cable length	m	1,5
IP protection class		IPX1
Net dimensions LxHxW	mm	500x520X1406
Packing Dimensions	mm	550x550x1460
Net Weight	Kg	72.0
Peso con serbatoio pieno d'acqua	Kg	182
Gross Weight	Kg	84.0
Sound power ****	dB (A)	48.5

NOTE:

* Heating capacity, power input based on the following conditions:

Ambient temperature 20°C, water temperature from 15°C to 55°C (obtained results by internal laboratory tests based on the uniform reintegration of the tank temperature).

**In relazione alla resistenza ausiliaria. Durante il ciclo di disinfezione, la temperatura viene innalzata a 70°C dalla resistenza ausiliaria

*** Obtained with the tank stored at an ambient temperature of 20°C, with air inlet of the duct at 7°C and all other parameters in accordance with EN 16147.

****According to EN 12102: ducted unit in/out 2m.

16 WORKING LIMITS OF HEAT PUMP

It's recommended to operate unit inside the working limits that are reported here below, in order to avoid any possible intervention of the safety and protection devices.

In any case, as regards high temperatures for water, if the setting temperature is outside the operating region, the unit will automatically adapt its set of the water temperature respecting the limits shown in the below diagram.

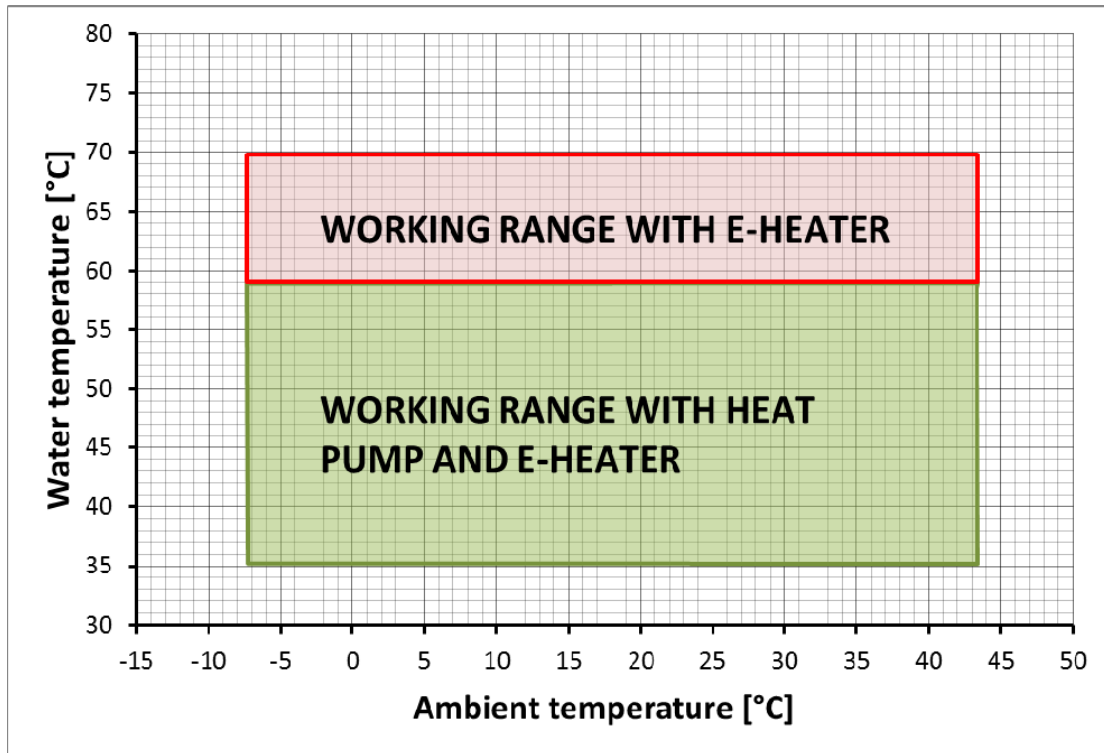

Here below the fixed sets of the pressure switches:

- HP switch: OFF=25 bar, ON=18 bar
- LP switch: OFF=0,2 bar, ON=1 bar

17 WIRING DIAGRAM

Please refer to the wiring diagram stuck on the electric box.

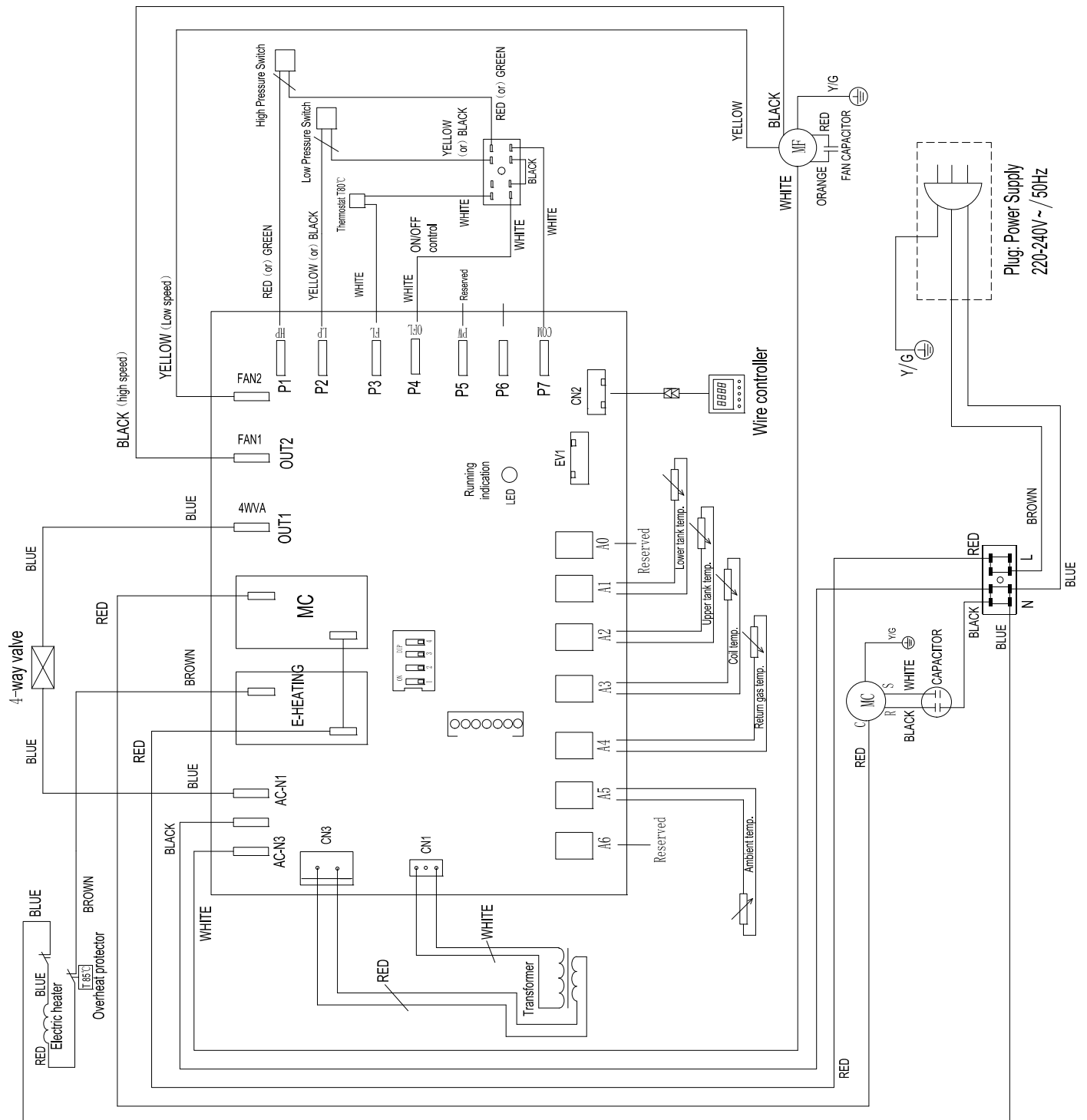

18 FICHE ACCORDING TO REGULATION (EU) No 812/2013

Modelli / Models		CALIDO 110
Profilo di carico dichiarato / Declared load profile		M
Classe di efficienza energetica di riscaldamento dell'acqua Water heating energy efficiency class		A +
Efficienza energetica di riscaldamento dell'acqua Water heating energy efficiency	Aria interna +20°C / Indoor air +20°C	157%
	Condizioni climatiche più calde (+14°C) Warmer climate condition	138%
	Condizioni climatiche medie (+7°C) Average climate conditions	125%
	Condizioni climatiche più fredde (+2°C) Colder climate conditions	113%
Consumo annuo di energia in termini di energia finale Annual energy consumption in terms of final energy	Aria interna +20°C / Indoor air +20°C	328 kWh
	Condizioni climatiche più calde (+14°C) Warmer climate condition	369 kWh
	Condizioni climatiche medie (+7°C) Average climate conditions	410 kWh
	Condizioni climatiche più fredde (+2°C) Colder climate conditions	451 kWh
Impostazione temperatura termostato Thermostat temperature settings		55°C
Livello di potenza sonora all'interno L _{WA} Sound power level, indoor L _{WA}		49 dB(A)
Precauzioni di installazione e manutenzione Precautions for installation and maintenance		Per le indicazioni relative all'installazione e alla manutenzione riferirsi ai capitoli dedicati nel manuale utente-installatore. Read precautions for installation and maintenance at specific chapters on user's and installation's manual.

19 TECHNICAL PARAMETERS ACCORDING TO REGULATION (EU) No 814/2013

Modelli / Models		CALIDO 110
Consumo quotidiano di energia elettrica Q _{elec} Daily electricity consumption Q _{elec}	Aria interna +20°C / Indoor air +20°C	1,553 kWh
	Condizioni climatiche più calde (+14°C) Warmer climate condition	1,749 kWh
	Condizioni climatiche medie (+7°C) Average climate conditions	1,944 kWh
	Condizioni climatiche più fredde (+2°C) Colder climate conditions	2,138 kWh
Profilo di carico dichiarato / Declared load profile		M
Livello di potenza sonora all'interno / Sound power level, indoor L _{WA}		49 dB(A)
Acqua mista a 40°C V40 / Mixed water at 40°C V40		150 l
Efficienza energetica di riscaldamento dell'acqua Water heating energy efficiency	Aria interna +20°C / Indoor air +20°C	157%
	Condizioni climatiche più calde (+14°C) Warmer climate condition	138%
	Condizioni climatiche medie (+7°C) Average climate conditions	125%
	Condizioni climatiche più fredde (+2°C) Colder climate conditions	113%

